



- The swept path analysis provided is produced from a purely transport orientated view, and does not consider any political issues in terms of land ownership, or any other precincts raised, that may otherwise be restrictive.
- The drawing has been produced from Ordnance Survey Data and adjusted where necessary to reflect measurements taken on site with a tape measure.
- All swept path diagrams and assessments are made and calculated for the road movement of loaded trailer equipment carrying Turbine components. These dimensions are based on the turning circles and specification of Collett & Sons Ltd trailer equipment.
- This SPA is a means of providing evidence of minimum requirements of any one vehicle as a footprint and there is no safety factor or margin included.
- Turbine delivery vehicles can be both left and right hand drive vehicles, therefore due to drivers perception it must be assumed that every vehicle will not follow the exact same line and so a margin of additional space should be allowed for.
- Land take is usually referred to when land is required from Private Land Owners; road widening is usually referred to when land is required within highways boundaries. The boundaries between private land and highways property are assumed by using obvious demarcation such as fence lines/hedges etc. It should be noted that actual boundaries between highways and private land are not substantiated in this report and can only be authenticated by carrying out land searches.
- Police escorts and permits will be required for the movement of all of the components. Form 'BE16' permits will also be required to undertake the movement of the vehicle shown in the swept path analysis. These permits are at the discretion of the Highway Agency (HA). Therefore, approval of these 'permits for movements' by the HA are a major consideration before the physical capability to deliver these components are undertaken.
- In critical areas, where modifications are required, the road construction must be formed to the minimum specification contained in the Turbine Manufactures Transport Guidance Notes.
- The Turbine Manufactures Transport Guidance Notes will state the minimum road width required for the transport of components. Any roads below this stated width will require widening to reflect this regardless of any swept path analysis not indicating modifications.
- The information is privileged and confidential and is for the exclusive use of the nominated client.
- All dimensions in metres.
- © Crown copyright and database rights 2014. Ordnance Survey 0100031673 (EMAP)

UK Grid Reference:

- Area within red outline will be swept by tractor and trailer axles
- ▨ Hatched area within red outline to be levelled and prepared to accept axle loadings
- Area within magenta outline will be oversailed by load and projections
- Area within green outline will be oversailed by trailer body

	COLLETT & SONS LIMITED Victoria Terminal TEL: +44(0)8456 255288 Albert Road FAX: +44(0)8456 255244 Halifax, HX2 0DF WEB: www.collett.co.uk		DRAWN RJW DATE 09/11/2022 SCALE NTS SIZE A3	TITLE MAPPING ORDNANCE SURVEY NOT ADJUSTED PINCH POINT IDENTIFIED BY COLLETT	LOCATIONS CUSTOMER EASTCOASTGRIDSERVICESLtd SITE BRANXTON ENERGY STORAGE DWG. NO.

© 2022 Microsoft Corporation © 2022 Maxar © CNES (2022) Distribution Airbus DS

Swept Path indicates trailer utilising AUTOMATIC steering

Example Transformer on 8 Axle Modular Trailer
Ballast Tractor w/drawbar
Transformer Dims for Indicative Purposes only

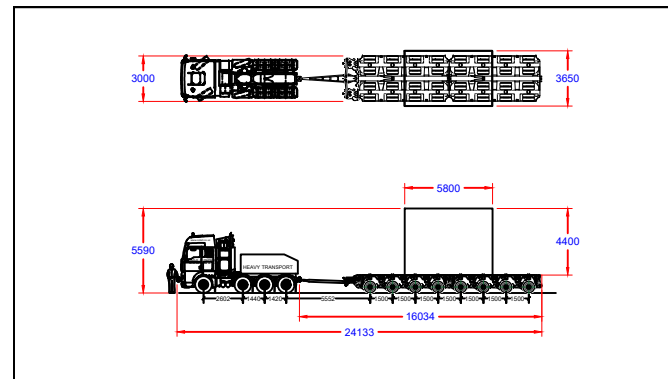

Continue on A1 and turn right onto unnamed road adjacent railway line.

****Caution****

- Utilisation of the full extents of the road are required at this location.
- The centre of gravity is assumed to be centre of the load, as agreed by client.

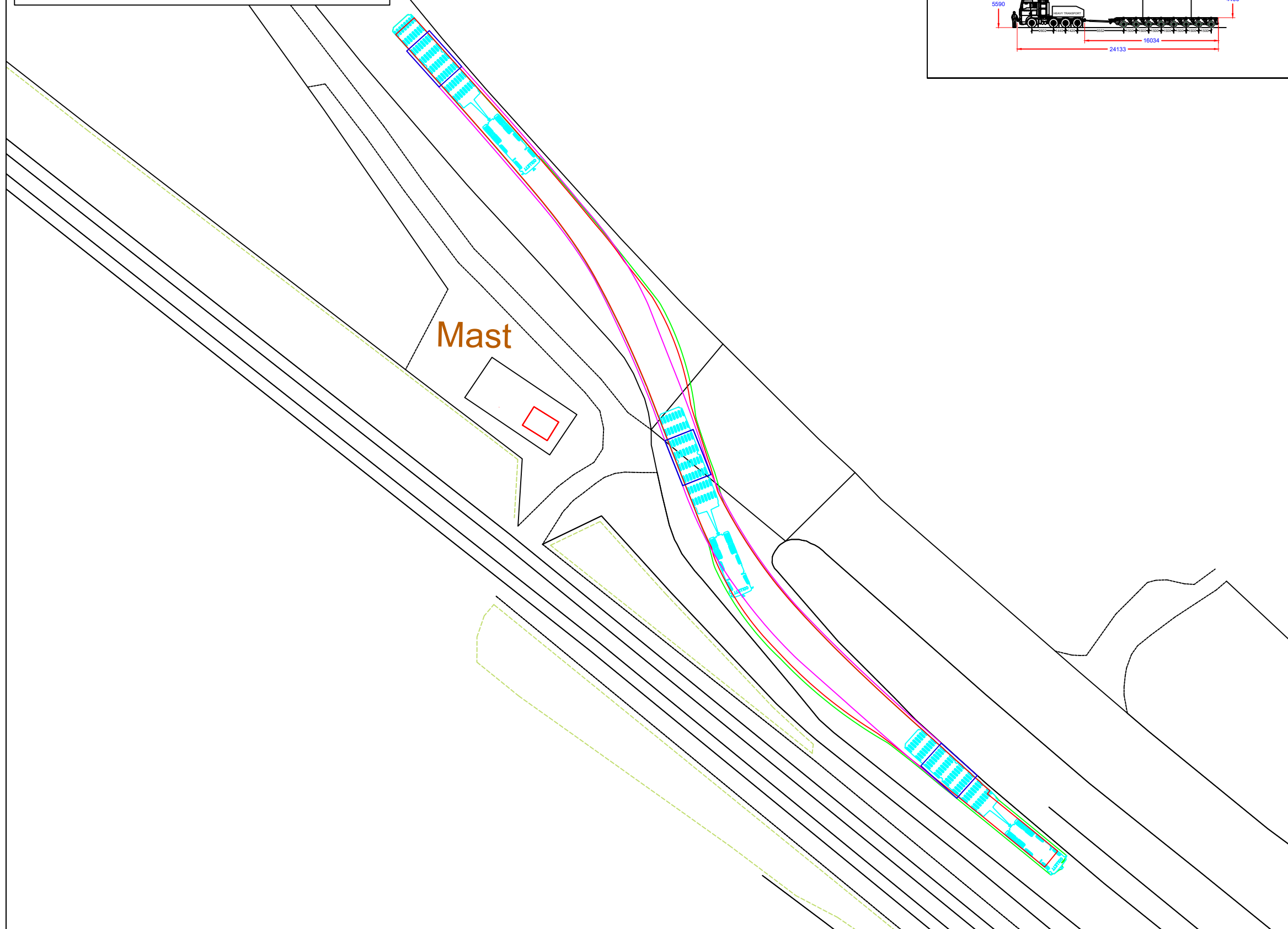

- The swept path analysis provided is produced from a purely transport orientated view, and does not consider any political issues in terms of land ownership, or any other precincts raised, that may otherwise be restrictive.
- The drawing has been produced from Ordnance Survey Data and adjusted where necessary to reflect measurements taken on site with a tape measure.
- All swept path diagrams and assessments are made and calculated for the road movement of loaded trailer equipment carrying Turbine components. These dimensions are based on the turning circles and specification of Collett & Sons Ltd trailer equipment.
- This SPA is a means of providing evidence of minimum requirements of any one vehicle as a footprint and there is no safety factor or margin included.
- Turbine delivery vehicles can be both left and right hand drive vehicles, therefore due to drivers perception it must be assumed that every vehicle will not follow the exact same line and so a margin of additional space should be allowed for.
- Land take is usually referred to when land is required from Private Land Owners; road widening is usually referred to when land is required within highways boundaries. The boundaries between private land and highways property are assumed by using obvious demarcation such as fence lines/hedges etc. It should be noted that actual boundaries between highways and private land are not substantiated in this report and can only be authenticated by carrying out land searches.
- Police escorts and permits will be required for the movement of all of the components. Form 'BE16' permits will also be required to undertake the movement of the vehicle shown in the swept path analysis. These permits are at the discretion of the Highway Agency (HA). Therefore, approval of these 'permits for movements' by the HA are a major consideration before the physical capability to deliver these components are undertaken.
- In critical areas, where modifications are required, the road construction must be formed to the minimum specification contained in the Turbine Manufactures Transport Guidance Notes.
- The Turbine Manufactures Transport Guidance Notes will state the minimum road width required for the transport of components. Any roads below this stated width will require widening to reflect this regardless of any swept path analysis not indicating modifications.
- The information is privileged and confidential and is for the exclusive use of the nominated client.
- All dimensions in metres.
- © Crown copyright and database rights 2014. Ordnance Survey 0100031673 (EMAP)

UK Grid Reference: NT 75862 73133

- Area within red outline will be swept by tractor and trailer axles
- ▨ Hatched area within red outline to be levelled and prepared to accept axle loadings
- Area within magenta outline will be oversailed by load and projections
- Area within green outline will be oversailed by trailer body

	COLLETT & SONS LIMITED Victoria Terminal TEL: +44(0)8456 255288 Albert Road FAX: +44(0)8456 255244 Halifax, HX2 0DF WEB: www.collett.co.uk		DRAWN RJW DATE 09/11/2022 SCALE 1:500	TITLE MAPPING ORDNANCE SURVEY NOT ADJUSTED PINCH POINT IDENTIFIED BY COLLETT	EXIT OF A1 ADJACENT RAILWAY LINE CUSTOMER EASTCOASTGRIDSERVICESLtd SITE BRANXTON ENERGY STORAGE DWG. NO. 380548-250A0.1
	SIZE A3				

Swept Path indicates trailer utilising MANUAL steering

Example Transformer on 8 Axle Modular Trailer
Ballast Tractor w/drawbar
Transformer Dims for Indicative Purposes only

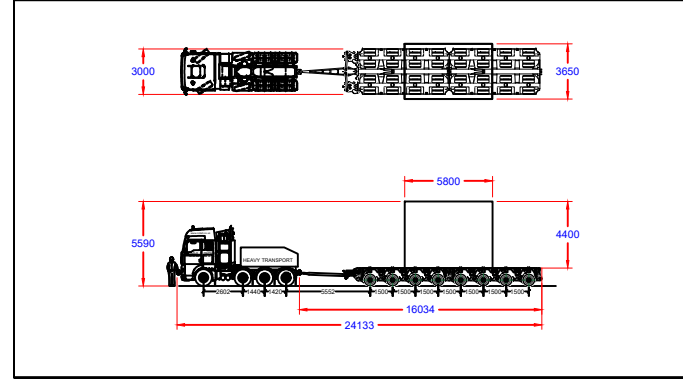

Continue on the road, crossing over the railway track and turn immediately right towards Oldhamstocks.
****Caution****

- Road widening is required on the nearside of the road, displayed in red hatching.
- Oversail of the verge will occur on both sides of the second left bend.
- The hedgerow on the nearside of the second bend is to be pruned.
- Manual steering & utilisation of the full extents of the road are required at this location.
- The centre of gravity is assumed to be centre of the load, as agreed by client.

- The swept path analysis provided is produced from a purely transport orientated view, and does not consider any political issues in terms of land ownership, or any other precincts raised, that may otherwise be restrictive.
- The drawing has been produced from Ordnance Survey Data and adjusted where necessary to reflect measurements taken on site with a tape measure.
- All swept path diagrams and assessments are made and calculated for the road movement of loaded trailer equipment carrying Turbine components. These dimensions are based on the turning circles and specification of Collett & Sons Ltd trailer equipment.
- This SPA is a means of providing evidence of minimum requirements of any one vehicle as a footprint and there is no safety factor or margin included.
- Turbine delivery vehicles can be both left and right hand drive vehicles, therefore due to drivers perception it must be assumed that every vehicle will not follow the exact same line and so a margin of additional space should be allowed for.
- Land take is usually referred to when land is required from Private Land Owners; road widening is usually referred to when land is required within highways boundaries. The boundaries between private land and highways property are assumed by using obvious demarcation such as fence lines/hedges etc. It should be noted that actual boundaries between highways and private land are not substantiated in this report and can only be authenticated by carrying out land searches.
- Police escorts and permits will be required for the movement of all of the components. Form 'BE16' permits will also be required to undertake the movement of the vehicle shown in the swept path analysis. These permits are at the discretion of the Highway Agency (HA). Therefore, approval of these 'permits for movements' by the HA are a major consideration before the physical capability to deliver these components are undertaken.
- In critical areas, where modifications are required, the road construction must be formed to the minimum specification contained in the Turbine Manufactures Transport Guidance Notes.
- The Turbine Manufactures Transport Guidance Notes will state the minimum road width required for the transport of components. Any roads below this stated width will require widening to reflect this regardless of any swept path analysis not indicating modifications.
- The information is privileged and confidential and is for the exclusive use of the nominated client.
- All dimensions in metres.
- © Crown copyright and database rights 2014. Ordnance Survey 0100031673 (EMAP)

MP 0.25

GP

Oversail of verge

Road widening required

Prune hedgerow

UK Grid Reference: NT 76083 72903

- Area within red outline will be swept by tractor and trailer axles
- ▨ Hatched area within red outline to be levelled and prepared to accept axle loadings
- Area within magenta outline will be oversailed by load and projections
- Area within green outline will be oversailed by trailer body



COLLETT & SONS LIMITED
Victoria Terminal TEL: +44(0)8456 255288
Albert Road FAX: +44(0)8456 255244
Halifax, HX2 0DF WEB: www.collett.co.uk

DRAWN	RJW	TITLE	BRIDGE CROSSING RAILWAY & RIGHT TURN	
DATE	08/11/2022	MAPPING	ORDNANCE SURVEY NOT ADJUSTED	CUSTOMER
SCALE	1:500	SIZE	A3	PINCH POINT IDENTIFIED BY
		COLLETT	SITE	BRANXTON ENERGY STORAGE
				DWG. NO. 380548-260A1.1
				EASTCOASTGRIDSERVICESLtd

Swept Path indicates trailer utilising MANUAL steering

Example Transformer on 8 Axle Modular Trailer
Ballast Tractor w/drawbar
Transformer Dims for Indicative Purposes only

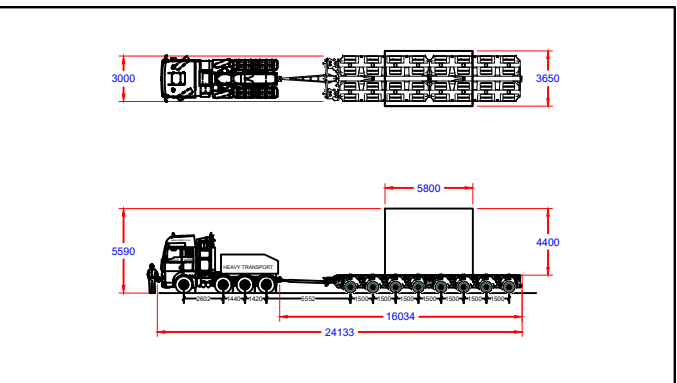

Continue along road.

****Caution****

- Road widening is required in the red hatched areas.
- An area of embankment on the nearside is to be cut back to allow the road to be widened.
- Telegraph pole is to be removed where indicated.
- Vegetation are to be pruned where indicated.
- Manual steering & utilisation of the full extents of the road are required at this location.

● The centre of gravity is assumed to be centre of the load, as agreed by client.

- The swept path analysis provided is produced from a purely transport orientated view, and does not consider any political issues in terms of land ownership, or any other precincts raised, that may otherwise be restrictive.
- The drawing has been produced from Ordnance Survey Data and adjusted where necessary to reflect measurements taken on site with a tape measure.
- All swept path diagrams and assessments are made and calculated for the road movement of loaded trailer equipment carrying Turbine components. These dimensions are based on the turning circles and specification of Collett & Sons Ltd trailer equipment.
- This SPA is a means of providing evidence of minimum requirements of any one vehicle as a footprint and there is no safety factor or margin included.
- Turbine delivery vehicles can be both left and right hand drive vehicles, therefore due to drivers perception it must be assumed that every vehicle will not follow the exact same line and so a margin of additional space should be allowed for.
- Land take is usually referred to when land is required from Private Land Owners; road widening is usually referred to when land is required within highways boundaries. The boundaries between private land and highways property are assumed by using obvious demarcation such as fence lines/hedges etc. It should be noted that actual boundaries between highways and private land are not substantiated in this report and can only be authenticated by carrying out land searches.
- Police escorts and permits will be required for the movement of all of the components. Form 'BE16' permits will also be required to undertake the movement of the vehicle shown in the swept path analysis. These permits are at the discretion of the Highway Agency (HA). Therefore, approval of these 'permits for movements' by the HA are a major consideration before the physical capability to deliver these components are undertaken.
- In critical areas, where modifications are required, the road construction must be formed to the minimum specification contained in the Turbine Manufactures Transport Guidance Notes.
- The Turbine Manufactures Transport Guidance Notes will state the minimum road width required for the transport of components. Any roads below this stated width will require widening to reflect this regardless of any swept path analysis not indicating modifications.
- The information is privileged and confidential and is for the exclusive use of the nominated client.
- All dimensions in metres.
- © Crown copyright and database rights 2014. Ordnance Survey 0100031673 (EMAP)

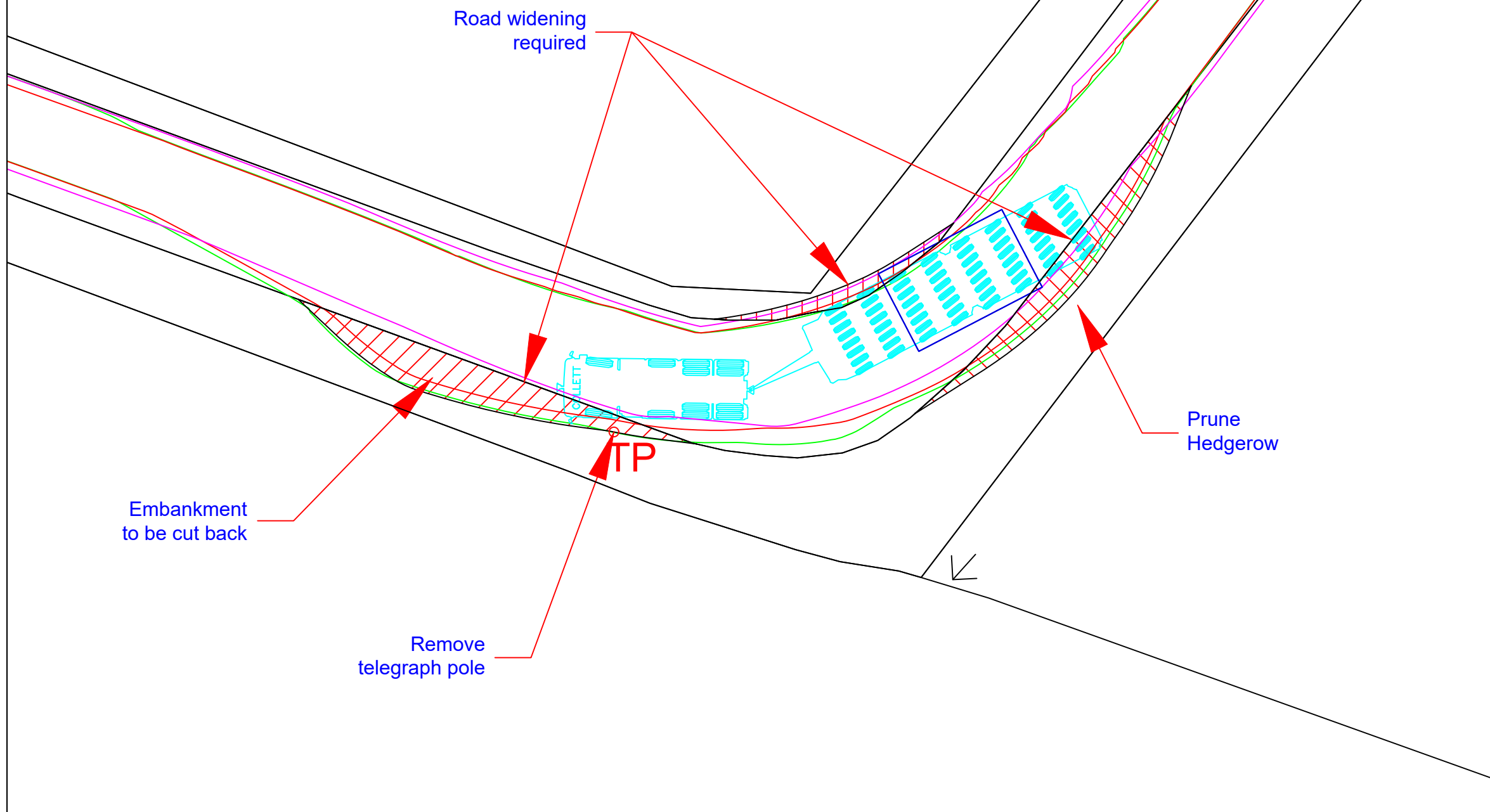

UK Grid Reference: NT 75766 72554

- Area within red outline will be swept by tractor and trailer axles
- ▨ Hatched area within red outline to be levelled and prepared to accept axle loadings
- Area within magenta outline will be oversailed by load and projections
- Area within green outline will be oversailed by trailer body



COLLETT & SONS LIMITED
Victoria Terminal TEL: +44(0)8456 255288
Albert Road FAX: +44(0)8456 255244
Halifax, HX2 0DF WEB: www.collett.co.uk

DRAWN	RJW	TITLE	RIGHT BEND OF 'S' BEND	
DATE	08/11/2022	MAPPING	ORDNANCE SURVEY NOT ADJUSTED	CUSTOMER
SCALE	1:200	SIZE	A3	PINCH POINT IDENTIFIED BY
		COLLETT		SITE BRANXTON ENERGY STORAGE
				DWG. NO. 380548-270A1.1

Swept Path indicates trailer utilising MANUAL steering

Example Transformer on 8 Axle Modular Trailer
Ballast Tractor w/drawbar
Transformer Dims for Indicative Purposes only

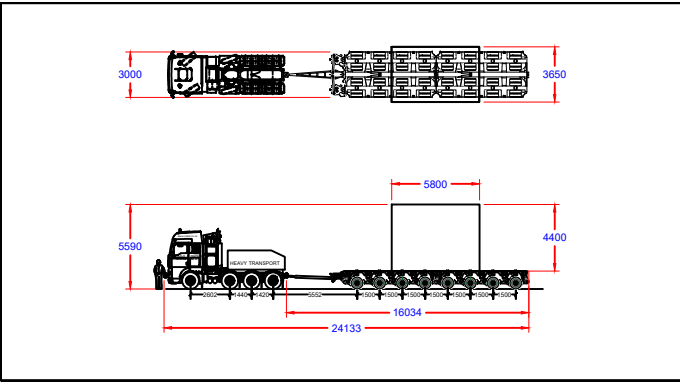

Continue following road.

****Caution****

- Road widening is required on the offside of the bend in the red hatched area.
- Oversail will occur on the nearside of the bend in the area of solid blue.
- Manual steering & utilisation of the full extents of the road are required at this location.
- Road to be upgraded to meet manufacturer's specification where necessary.
- Trees to be pruned on both sides of the road.
- The centre of gravity is assumed to be centre of the load, as agreed by client.

71.3m

Road widening required

Oversail of verge

- The swept path analysis provided is produced from a purely transport orientated view, and does not consider any political issues in terms of land ownership, or any other precincts raised, that may otherwise be restrictive.
- The drawing has been produced from Ordnance Survey Data and adjusted where necessary to reflect measurements taken on site with a tape measure.
- All swept path diagrams and assessments are made and calculated for the road movement of loaded trailer equipment carrying Turbine components. These dimensions are based on the turning circles and specification of Collett & Sons Ltd trailer equipment.
- This SPA is a means of providing evidence of minimum requirements of any one vehicle as a footprint and there is no safety factor or margin included.
- Turbine delivery vehicles can be both left and right hand drive vehicles, therefore due to drivers perception it must be assumed that every vehicle will not follow the exact same line and so a margin of additional space should be allowed for.
- Land take is usually referred to when land is required from Private Land Owners; road widening is usually referred to when land is required within highways boundaries. The boundaries between private land and highways property are assumed by using obvious demarcation such as fence lines/hedges etc. It should be noted that actual boundaries between highways and private land are not substantiated in this report and can only be authenticated by carrying out land searches.
- Police escorts and permits will be required for the movement of all of the components. Form 'BE16' permits will also be required to undertake the movement of the vehicle shown in the swept path analysis. These permits are at the discretion of the Highway Agency (HA). Therefore, approval of these 'permits for movements' by the HA are a major consideration before the physical capability to deliver these components are undertaken.
- In critical areas, where modifications are required, the road construction must be formed to the minimum specification contained in the Turbine Manufactures Transport Guidance Notes.
- The Turbine Manufactures Transport Guidance Notes will state the minimum road width required for the transport of components. Any roads below this stated width will require widening to reflect this regardless of any swept path analysis not indicating modifications.
- The information is privileged and confidential and is for the exclusive use of the nominated client.
- All dimensions in metres.
- © Crown copyright and database rights 2014. Ordnance Survey 0100031673 (EMAP)

UK Grid Reference: NT 75640 72595

- Area within red outline will be swept by tractor and trailer axles
- ▨ Hatched area within red outline to be levelled and prepared to accept axle loadings
- Area within magenta outline will be oversailed by load and projections
- Area within green outline will be oversailed by trailer body



COLLETT & SONS LIMITED
Victoria Terminal TEL: +44(0)8456 255288
Albert Road FAX: +44(0)8456 255244
Halifax, HX2 0DF WEB: www.collett.co.uk

DRAWN	RJW	TITLE	LEFT BEND OF 'S' BEND	
DATE	08/11/2022	MAPPING	ORDNANCE SURVEY NOT ADJUSTED	CUSTOMER
SCALE	1:200	SIZE	A3	PINCH POINT IDENTIFIED BY
		COLLETT		SITE BRANXTON ENERGY STORAGE
				DWG. NO. 380548-280A1.1

Swept Path indicates trailer utilising MANUAL steering

Example Transformer on 8 Axle Modular Trailer
Ballast Tractor w/drawbar
Transformer Dims for Indicative Purposes only

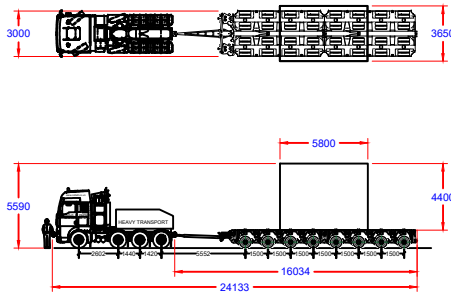

Continue forward on road.

****Caution****

- Road widening is required on the nearside in the red hatched area.
- Oversail of the verge will occur on the offside of the road as demarked by the solid blue area.
- Hedgerow is to be pruned where indicated.
- Manual steering & utilisation of the full extents of the road are required at this location.

- Road to be upgraded to meet manufacturer's specification where necessary.
- The centre of gravity is assumed to be centre of the load, as agreed by client.

- The swept path analysis provided is produced from a purely transport orientated view, and does not consider any political issues in terms of land ownership, or any other precincts raised, that may otherwise be restrictive.
- The drawing has been produced from Ordnance Survey Data and adjusted where necessary to reflect measurements taken on site with a tape measure.
- All swept path diagrams and assessments are made and calculated for the road movement of loaded trailer equipment carrying Turbine components. These dimensions are based on the turning circles and specification of Collett & Sons Ltd trailer equipment.
- This SPA is a means of providing evidence of minimum requirements of any one vehicle as a footprint and there is no safety factor or margin included.
- Turbine delivery vehicles can be both left and right hand drive vehicles, therefore due to drivers perception it must be assumed that every vehicle will not follow the exact same line and so a margin of additional space should be allowed for.
- Land take is usually referred to when land is required from Private Land Owners; road widening is usually referred to when land is required within highways boundaries. The boundaries between private land and highways property are assumed by using obvious demarcation such as fence lines/hedges etc. It should be noted that actual boundaries between highways and private land are not substantiated in this report and can only be authenticated by carrying out land searches.
- Police escorts and permits will be required for the movement of all of the components. Form 'BE16' permits will also be required to undertake the movement of the vehicle shown in the swept path analysis. These permits are at the discretion of the Highway Agency (HA). Therefore, approval of these 'permits for movements' by the HA are a major consideration before the physical capability to deliver these components are undertaken.
- In critical areas, where modifications are required, the road construction must be formed to the minimum specification contained in the Turbine Manufactures Transport Guidance Notes.
- The Turbine Manufactures Transport Guidance Notes will state the minimum road width required for the transport of components. Any roads below this stated width will require widening to reflect this regardless of any swept path analysis not indicating modifications.
- The information is privileged and confidential and is for the exclusive use of the nominated client.
- All dimensions in metres.
- © Crown copyright and database rights 2014. Ordnance Survey 0100031673 (EMAP)

UK Grid Reference: NT 75504 72259

- Area within red outline will be swept by tractor and trailer axles
- ▨ Hatched area within red outline to be levelled and prepared to accept axle loadings
- Area within magenta outline will be oversailed by load and projections
- Area within green outline will be oversailed by trailer body

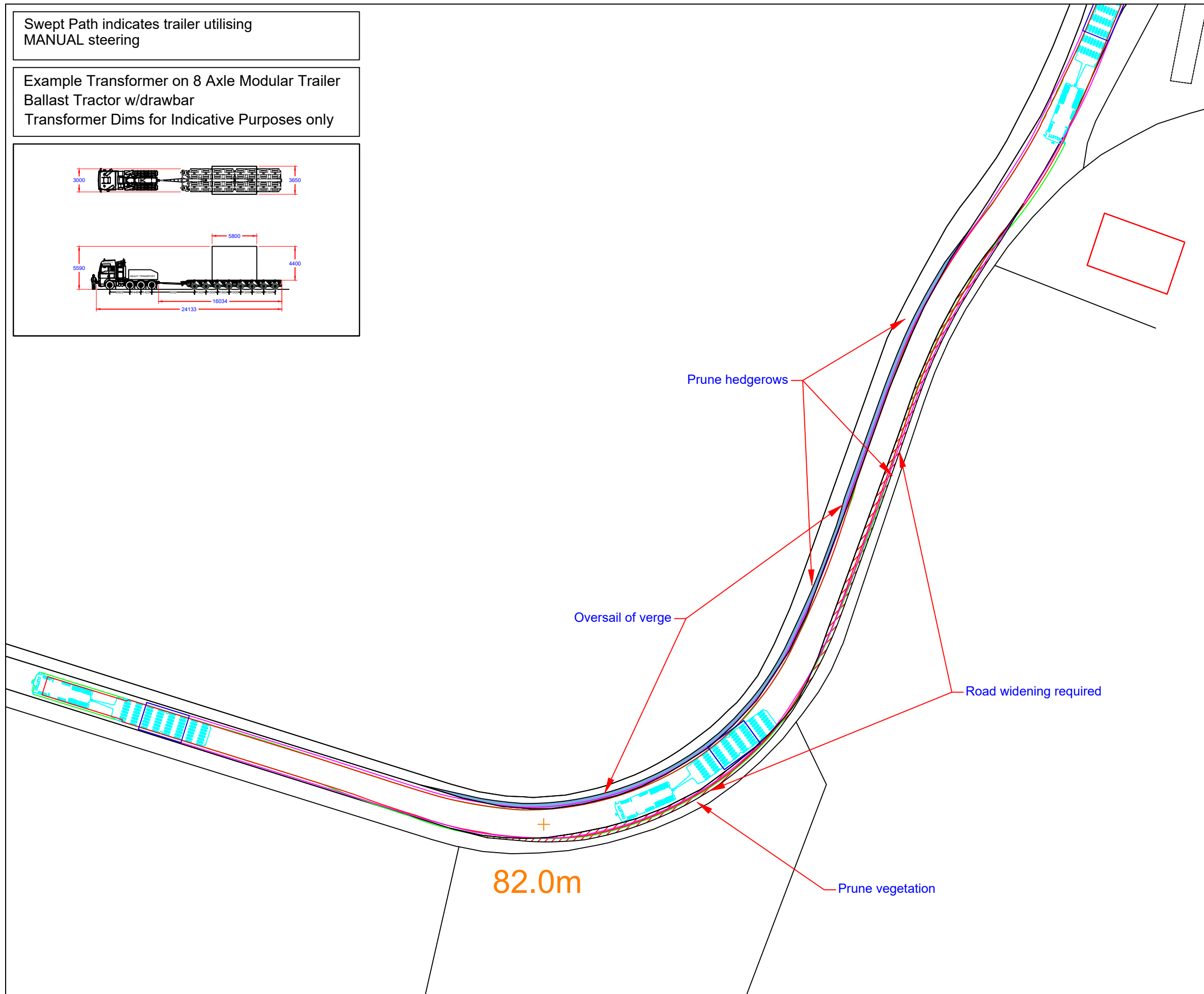

COLLETT & SONS LIMITED
Victoria Terminal TEL: +44(0)8456 255288
Albert Road FAX: +44(0)8456 255244
Halifax, HX2 0DF WEB: www.collett.co.uk

DRAWN RJW
DATE 09/11/2022
SCALE 1:250 SIZE A3

TITLE
MAPPING ORDNANCE SURVEY NOT ADJUSTED
PINCH POINT IDENTIFIED BY COLLETT

RIGHT BEND
CUSTOMER EASTCOASTGRIDSERVICESLtd
SITE BRANXTON ENERGY STORAGE DWG. NO. 380548-290A1.1

Swept Path indicates trailer utilising MANUAL steering

Example Transformer on 8 Axle Modular Trailer
Ballast Tractor w/drawbar
Transformer Dims for Indicative Purposes only

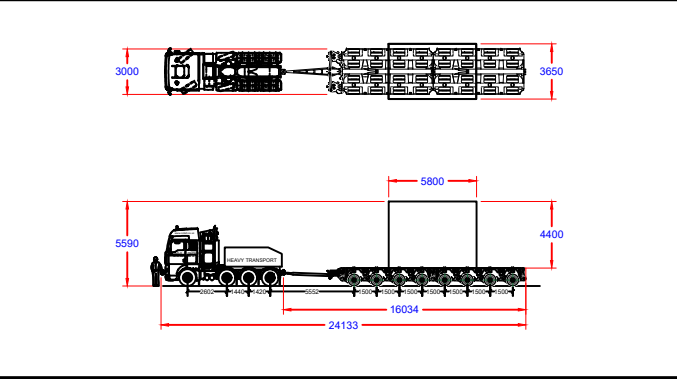

Continue on road. Turn right at the junction onto unnamed road.

****Caution****

- Road widening is required in the red hatched areas.
- A road sign is to be removed where indicated.
- Hedgerow is to be pruned where indicated.
- Manual steering & utilisation of the full extents of the road are required at this location.

● Road to be upgraded to meet manufacturer's specification where necessary.

● The centre of gravity is assumed to be centre of the load, as agreed by client.

- The swept path analysis provided is produced from a purely transport orientated view, and does not consider any political issues in terms of land ownership, or any other precincts raised, that may otherwise be restrictive.
- The drawing has been produced from Ordnance Survey Data and adjusted where necessary to reflect measurements taken on site with a tape measure.
- All swept path diagrams and assessments are made and calculated for the road movement of loaded trailer equipment carrying Turbine components. These dimensions are based on the turning circles and specification of Collett & Sons Ltd trailer equipment.
- This SPA is a means of providing evidence of minimum requirements of any one vehicle as a footprint and there is no safety factor or margin included.
- Turbine delivery vehicles can be both left and right hand drive vehicles, therefore due to drivers perception it must be assumed that every vehicle will not follow the exact same line and so a margin of additional space should be allowed for.
- Land take is usually referred to when land is required from Private Land Owners; road widening is usually referred to when land is required within highways boundaries. The boundaries between private land and highways property are assumed by using obvious demarcation such as fence lines/hedges etc. It should be noted that actual boundaries between highways and private land are not substantiated in this report and can only be authenticated by carrying out land searches.
- Police escorts and permits will be required for the movement of all of the components. Form 'BE16' permits will also be required to undertake the movement of the vehicle shown in the swept path analysis. These permits are at the discretion of the Highway Agency (HA). Therefore, approval of these 'permits for movements' by the HA are a major consideration before the physical capability to deliver these components are undertaken.
- In critical areas, where modifications are required, the road construction must be formed to the minimum specification contained in the Turbine Manufactures Transport Guidance Notes.
- The Turbine Manufactures Transport Guidance Notes will state the minimum road width required for the transport of components. Any roads below this stated width will require widening to reflect this regardless of any swept path analysis not indicating modifications.
- The information is privileged and confidential and is for the exclusive use of the nominated client.
- All dimensions in metres.
- © Crown copyright and database rights 2014. Ordnance Survey 0100031673 (EMAP)

Road widening required

Prune hedgerow

Remove road sign

Road widening required

Prune hedgerow

UK Grid Reference: NT 74920 72431

- Area within red outline will be swept by tractor and trailer axles
- ▨ Hatched area within red outline to be levelled and prepared to accept axle loadings
- Area within magenta outline will be oversailed by load and projections
- Area within green outline will be oversailed by trailer body



COLLETT & SONS LIMITED
Victoria Terminal TEL: +44(0)8456 255288
Albert Road FAX: +44(0)8456 255244
Halifax, HX2 0DF WEB: www.collett.co.uk

DRAWN	RJW	TITLE	RIGHT TURN ONTO UNNAMED TRACK	
DATE	08/11/2022	MAPPING	ORDNANCE SURVEY NOT ADJUSTED	CUSTOMER
SCALE	1:200	SIZE	A3	PINCH POINT IDENTIFIED BY
			COLLETT	SITE BRANXTON ENERGY STORAGE
				DWG. NO. 380548-300A1.1

Swept Path indicates trailer utilising MANUAL steering

Example Transformer on 8 Axle Modular Trailer
Ballast Tractor w/drawbar
Transformer Dims for Indicative Purposes only

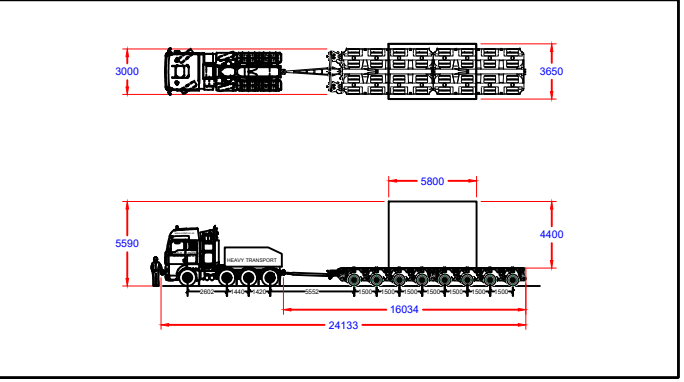

Continue on road.

****Caution****

- Road widening is required on the offside of the bend in the red hatched area.
- A road sign is to be removed on the offside.
- Hedgerow is to be pruned where indicated.
- Manual steering & utilisation of the full extents of the road are required at this location.

● Road to be upgraded to meet manufacturer's specification where necessary.

● The centre of gravity is assumed to be centre of the load, as agreed by client.

- The swept path analysis provided is produced from a purely transport orientated view, and does not consider any political issues in terms of land ownership, or any other precincts raised, that may otherwise be restrictive.
- The drawing has been produced from Ordnance Survey Data and adjusted where necessary to reflect measurements taken on site with a tape measure.
- All swept path diagrams and assessments are made and calculated for the road movement of loaded trailer equipment carrying Turbine components. These dimensions are based on the turning circles and specification of Collett & Sons Ltd trailer equipment.
- This SPA is a means of providing evidence of minimum requirements of any one vehicle as a footprint and there is no safety factor or margin included.
- Turbine delivery vehicles can be both left and right hand drive vehicles, therefore due to drivers perception it must be assumed that every vehicle will not follow the exact same line and so a margin of additional space should be allowed for.
- Land take is usually referred to when land is required from Private Land Owners; road widening is usually referred to when land is required within highways boundaries. The boundaries between private land and highways property are assumed by using obvious demarcation such as fence lines/hedges etc. It should be noted that actual boundaries between highways and private land are not substantiated in this report and can only be authenticated by carrying out land searches.
- Police escorts and permits will be required for the movement of all of the components. Form 'BE16' permits will also be required to undertake the movement of the vehicle shown in the swept path analysis. These permits are at the discretion of the Highway Agency (HA). Therefore, approval of these 'permits for movements' by the HA are a major consideration before the physical capability to deliver these components are undertaken.
- In critical areas, where modifications are required, the road construction must be formed to the minimum specification contained in the Turbine Manufactures Transport Guidance Notes.
- The Turbine Manufactures Transport Guidance Notes will state the minimum road width required for the transport of components. Any roads below this stated width will require widening to reflect this regardless of any swept path analysis not indicating modifications.
- The information is privileged and confidential and is for the exclusive use of the nominated client.
- All dimensions in metres.
- © Crown copyright and database rights 2014. Ordnance Survey 0100031673 (EMAP)

UK Grid Reference: NT 74876 72561

— Area within red outline will be swept by tractor and trailer axles

▨ Hatched area within red outline to be levelled and prepared to accept axle loadings

— Area within magenta outline will be oversailed by load and projections

— Area within green outline will be oversailed by trailer body

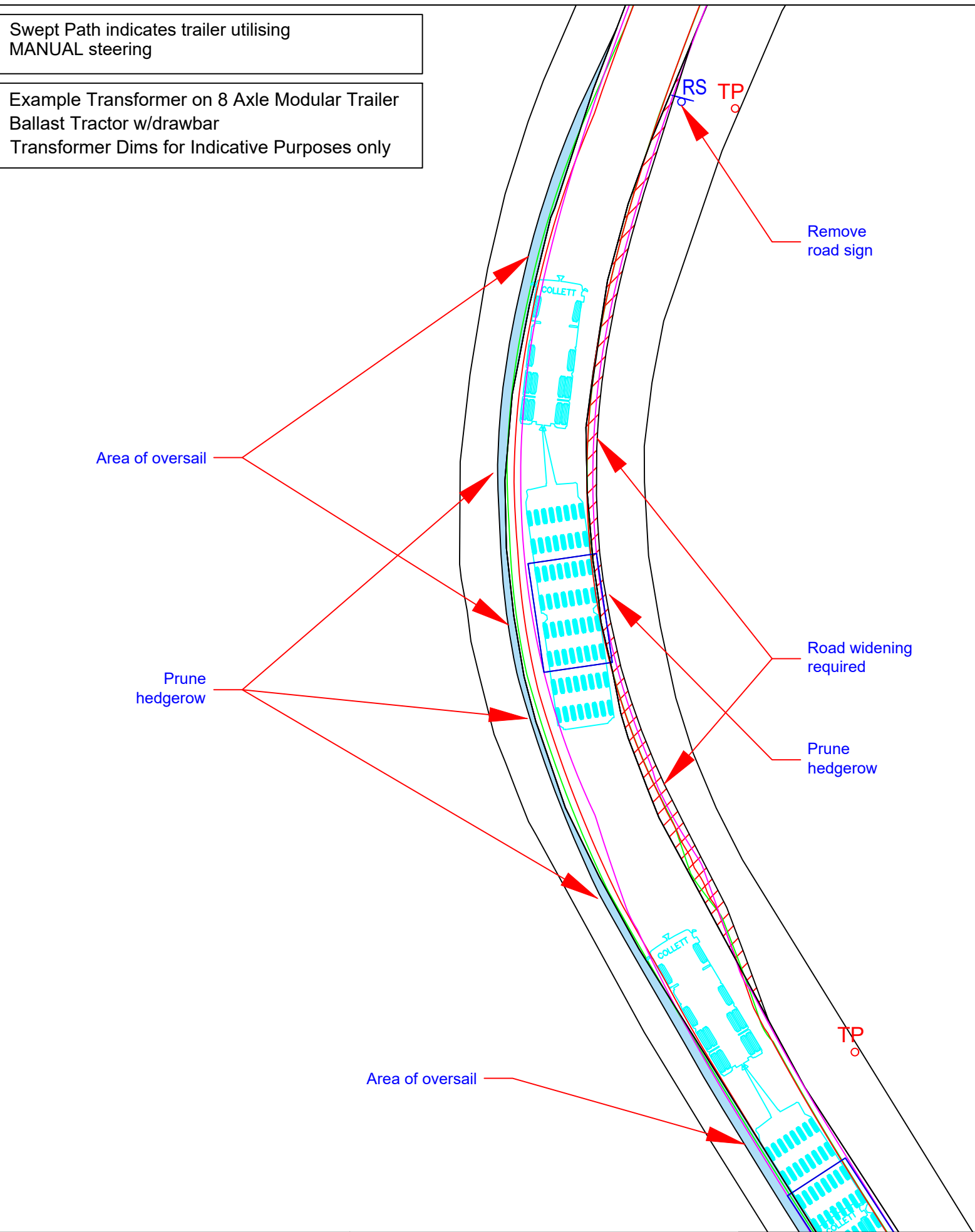

COLLETT & SONS LIMITED
Victoria Terminal TEL: +44(0)8456 255288
Albert Road FAX: +44(0)8456 255244
Halifax, HX2 0DF WEB: www.collett.co.uk

DRAWN RJW
DATE 08/11/2022
SCALE 1:250 SIZE A3

TITLE
MAPPING ORDNANCE SURVEY NOT ADJUSTED
PINCH POINT IDENTIFIED BY COLLETT

RIGHT BEND ON TRACK
CUSTOMER EASTCOASTGRIDSERVICESLtd
SITE BRANXTON ENERGY STORAGE DWG. NO. 380548-310A1.1

Swept Path indicates trailer utilising AUTOMATIC steering

Example Transformer on 8 Axle Modular Trailer
Ballast Tractor w/drawbar
Transformer Dims for Indicative Purposes only

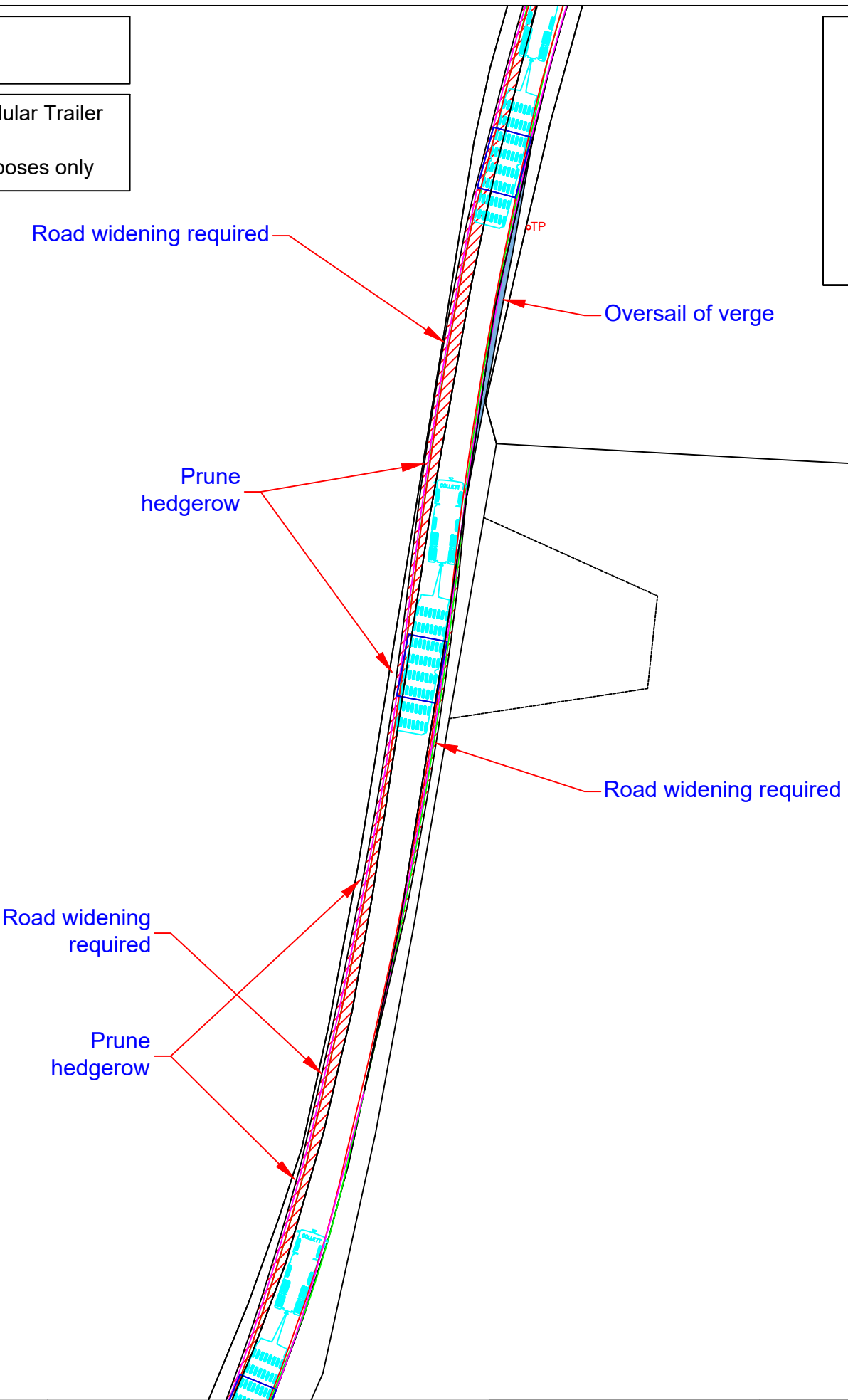
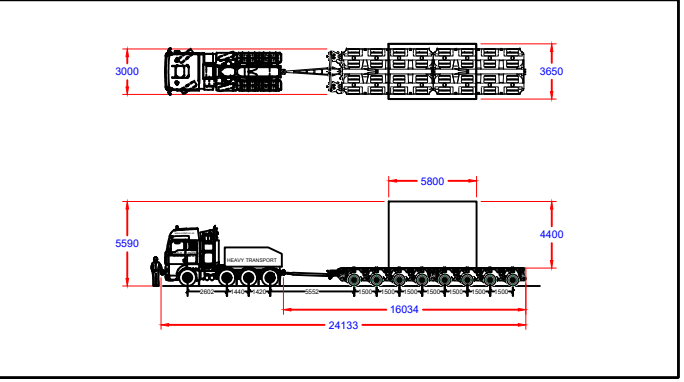

Continue along road.

****Caution****

- Road widening is required in the red hatched areas.
- Oversail will occur on the offside as shown in solid blue.
- Hedgerows are to be pruned on the nearside.
- Road to be upgraded to meet manufacturer's specification where necessary.
- The centre of gravity is assumed to be centre of the load, as agreed by client.

- The swept path analysis provided is produced from a purely transport orientated view, and does not consider any political issues in terms of land ownership, or any other precincts raised, that may otherwise be restrictive.
- The drawing has been produced from Ordnance Survey Data and adjusted where necessary to reflect measurements taken on site with a tape measure.
- All swept path diagrams and assessments are made and calculated for the road movement of loaded trailer equipment carrying Turbine components. These dimensions are based on the turning circles and specification of Collett & Sons Ltd trailer equipment.
- This SPA is a means of providing evidence of minimum requirements of any one vehicle as a footprint and there is no safety factor or margin included.
- Turbine delivery vehicles can be both left and right hand drive vehicles, therefore due to drivers perception it must be assumed that every vehicle will not follow the exact same line and so a margin of additional space should be allowed for.
- Land take is usually referred to when land is required from Private Land Owners; road widening is usually referred to when land is required within highways boundaries. The boundaries between private land and highways property are assumed by using obvious demarcation such as fence lines/hedges etc. It should be noted that actual boundaries between highways and private land are not substantiated in this report and can only be authenticated by carrying out land searches.
- Police escorts and permits will be required for the movement of all of the components. Form 'BE16' permits will also be required to undertake the movement of the vehicle shown in the swept path analysis. These permits are at the discretion of the Highway Agency (HA). Therefore, approval of these 'permits for movements' by the HA are a major consideration before the physical capability to deliver these components are undertaken.
- In critical areas, where modifications are required, the road construction must be formed to the minimum specification contained in the Turbine Manufactures Transport Guidance Notes.
- The Turbine Manufactures Transport Guidance Notes will state the minimum road width required for the transport of components. Any roads below this stated width will require widening to reflect this regardless of any swept path analysis not indicating modifications.
- The information is privileged and confidential and is for the exclusive use of the nominated client.
- All dimensions in metres.
- © Crown copyright and database rights 2014. Ordnance Survey 0100031673 (EMAP)

UK Grid Reference: NT 74964 72791

- Area within red outline will be swept by tractor and trailer axles
- ▨ Hatched area within red outline to be levelled and prepared to accept axle loadings
- Area within magenta outline will be oversailed by load and projections
- Area within green outline will be oversailed by trailer body



COLLETT & SONS LIMITED
Victoria Terminal TEL: +44(0)8456 255288
Albert Road FAX: +44(0)8456 255244
Halifax, HX2 0DF WEB: www.collett.co.uk

DRAWN RJW
DATE 10/11/2022
SCALE 1:500 SIZE A3

TITLE MAPPING ORDNANCE SURVEY NOT ADJUSTED
PINCH POINT IDENTIFIED BY COLLETT

LEFT BEND ON TRACK
CUSTOMER EASTCOASTGRIDSERVICESLtd
SITE BRANXTON ENERGY STORAGE DWG. NO. 380548-320A0.1

Swept Path indicates trailer utilising AUTOMATIC steering

Example Transformer on 8 Axle Modular Trailer
Ballast Tractor w/drawbar
Transformer Dims for Indicative Purposes only

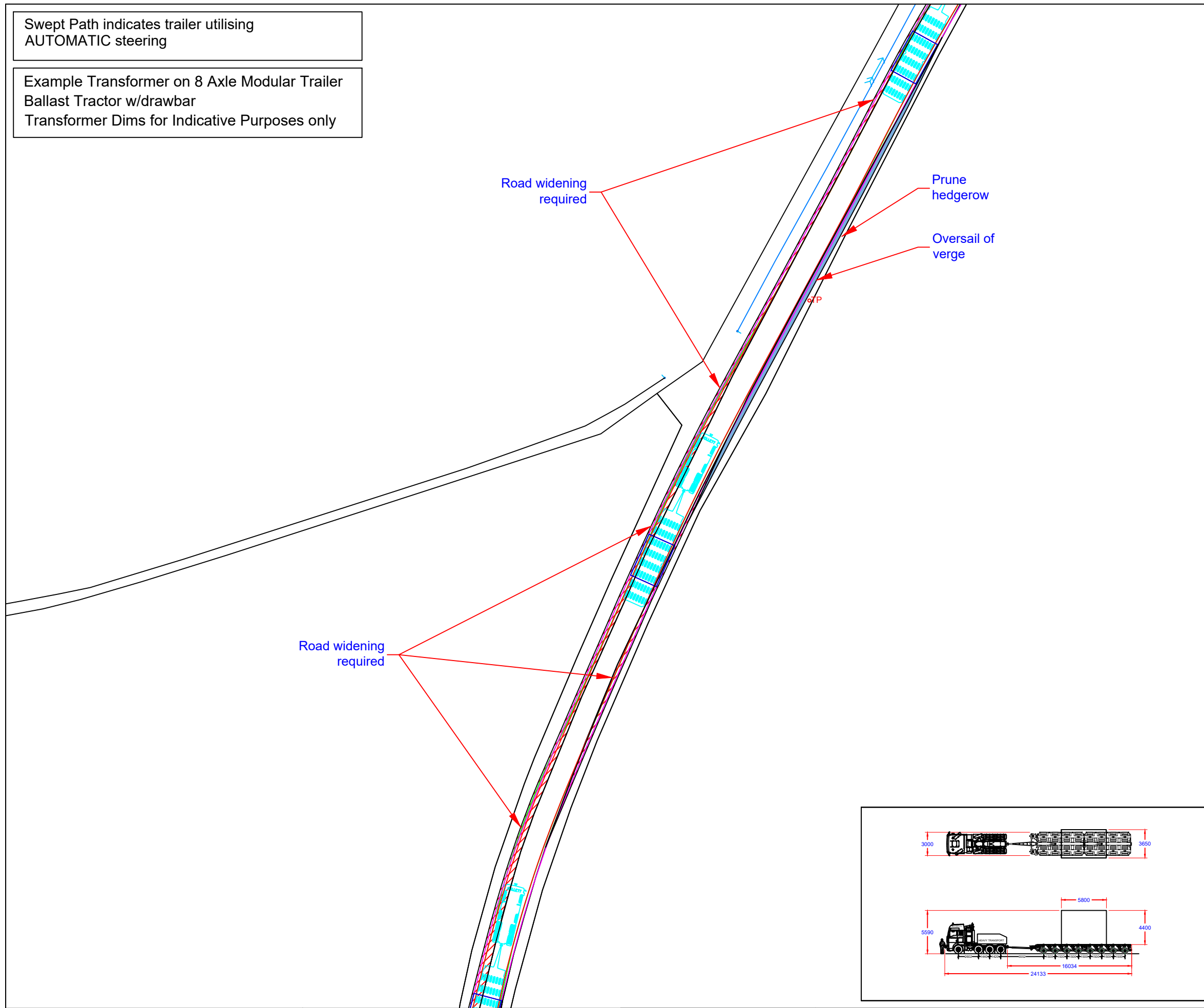

Continue along road.

****Caution****

- Road widening is required in the red hatched areas.
- Oversail will occur on the offside as demarked by area of blue shading.
- Hedgerow on the offside is to be pruned where indicated.
- Road to be upgraded to meet manufacturer's specification where necessary.
- The centre of gravity is assumed to be centre of the load, as agreed by client.

- The swept path analysis provided is produced from a purely transport orientated view, and does not consider any political issues in terms of land ownership, or any other precincts raised, that may otherwise be restrictive.
- The drawing has been produced from Ordnance Survey Data and adjusted where necessary to reflect measurements taken on site with a tape measure.
- All swept path diagrams and assessments are made and calculated for the road movement of loaded trailer equipment carrying Turbine components. These dimensions are based on the turning circles and specification of Collett & Sons Ltd trailer equipment.
- This SPA is a means of providing evidence of minimum requirements of any one vehicle as a footprint and there is no safety factor or margin included.
- Turbine delivery vehicles can be both left and right hand drive vehicles, therefore due to drivers perception it must be assumed that every vehicle will not follow the exact same line and so a margin of additional space should be allowed for.
- Land take is usually referred to when land is required from Private Land Owners; road widening is usually referred to when land is required within highways boundaries. The boundaries between private land and highways property are assumed by using obvious demarcation such as fence lines/hedges etc. It should be noted that actual boundaries between highways and private land are not substantiated in this report and can only be authenticated by carrying out land searches.
- Police escorts and permits will be required for the movement of all of the components. Form 'BE16' permits will also be required to undertake the movement of the vehicle shown in the swept path analysis. These permits are at the discretion of the Highway Agency (HA). Therefore, approval of these 'permits for movements' by the HA are a major consideration before the physical capability to deliver these components are undertaken.
- In critical areas, where modifications are required, the road construction must be formed to the minimum specification contained in the Turbine Manufactures Transport Guidance Notes.
- The Turbine Manufactures Transport Guidance Notes will state the minimum road width required for the transport of components. Any roads below this stated width will require widening to reflect this regardless of any swept path analysis not indicating modifications.
- The information is privileged and confidential and is for the exclusive use of the nominated client.
- All dimensions in metres.
- © Crown copyright and database rights 2014. Ordnance Survey 0100031673 (EMAP)

UK Grid Reference: NT 75007 72930

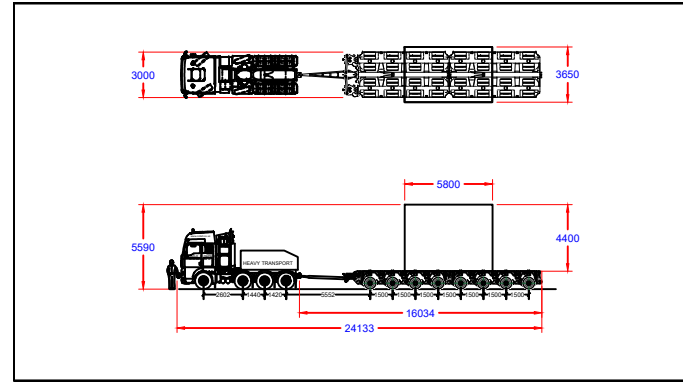

- Area within red outline will be swept by tractor and trailer axles
- ▨ Hatched area within red outline to be levelled and prepared to accept axle loadings
- Area within magenta outline will be oversailed by load and projections
- Area within green outline will be oversailed by trailer body



COLLETT & SONS LIMITED
Victoria Terminal TEL: +44(0)8456 255288
Albert Road FAX: +44(0)8456 255244
Halifax, HX2 0DF WEB: www.collett.co.uk

DRAWN	RJW	TITLE	RIGHT BEND ON TRACK	
DATE	10/11/2022	MAPPING	ORDNANCE SURVEY NOT ADJUSTED	CUSTOMER
SCALE	1:500	SIZE	A3	PINCH POINT IDENTIFIED BY
			COLLETT	SITE BRANXTON ENERGY STORAGE
				DWG. NO. 380548-330A0.1
				EASTCOASTGRIDSERVICESLtd

Swept Path indicates trailer utilising AUTOMATIC steering

Example Transformer on 8 Axle Modular Trailer
Ballast Tractor w/drawbar
Transformer Dims for Indicative Purposes only

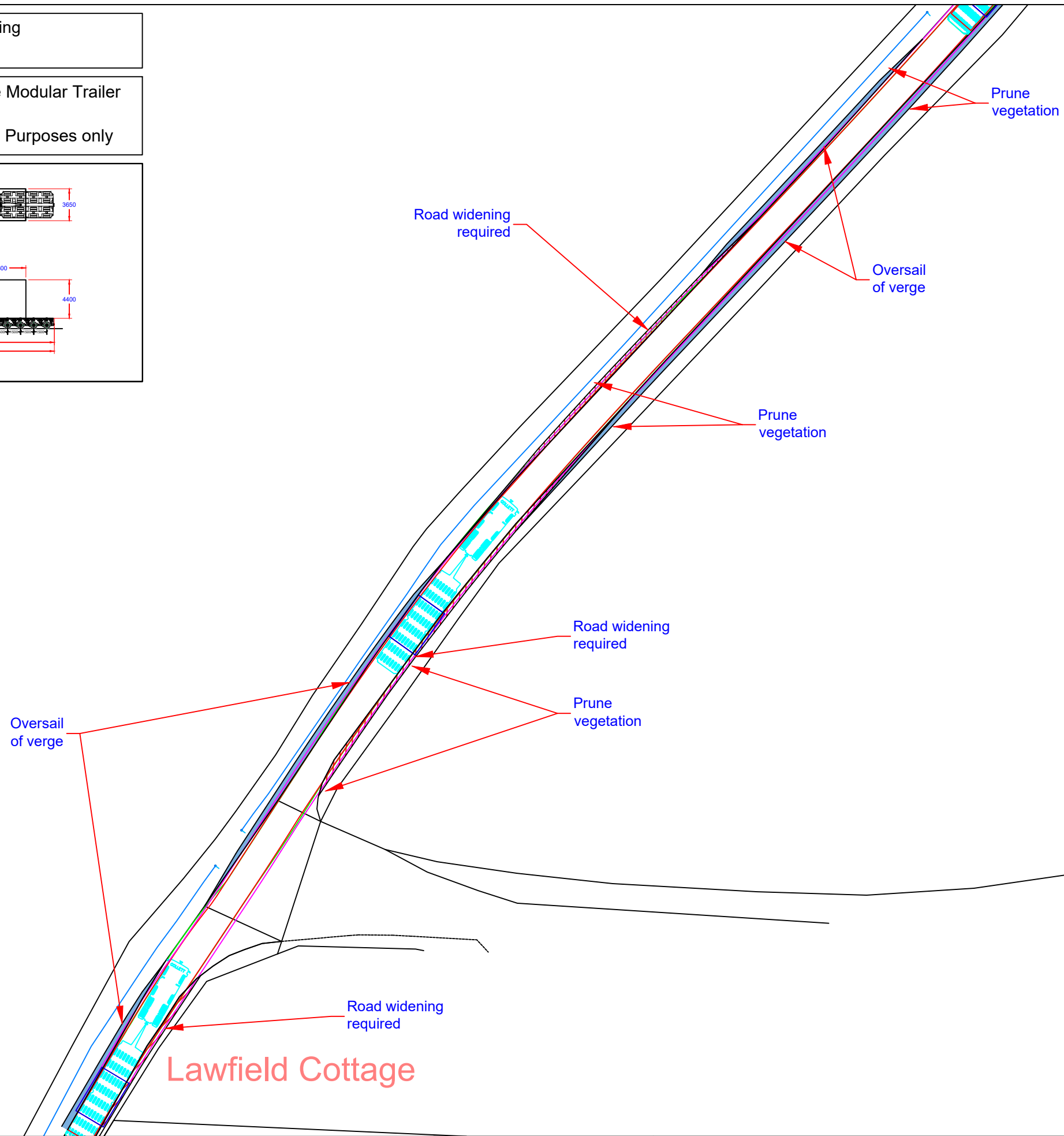
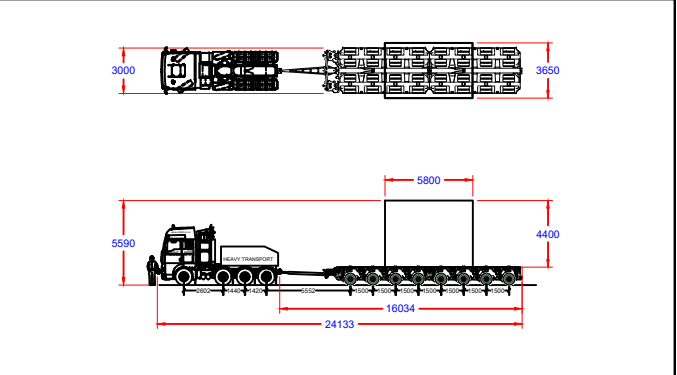

Continue along road.

- **Caution****
- Road widening is required in the red hatched areas.
 - Hedgerows/ vegetation are to be pruned on both sides where indicated.
 - Road to be upgraded to meet manufacturer's specification where necessary.
 - The centre of gravity is assumed to be centre of the load, as agreed by client.

- The swept path analysis provided is produced from a purely transport orientated view, and does not consider any political issues in terms of land ownership, or any other precincts raised, that may otherwise be restrictive.
- The drawing has been produced from Ordnance Survey Data and adjusted where necessary to reflect measurements taken on site with a tape measure.
- All swept path diagrams and assessments are made and calculated for the road movement of loaded trailer equipment carrying Turbine components. These dimensions are based on the turning circles and specification of Collett & Sons Ltd trailer equipment.
- This SPA is a means of providing evidence of minimum requirements of any one vehicle as a footprint and there is no safety factor or margin included.
- Turbine delivery vehicles can be both left and right hand drive vehicles, therefore due to drivers perception it must be assumed that every vehicle will not follow the exact same line and so a margin of additional space should be allowed for.
- Land take is usually referred to when land is required from Private Land Owners; road widening is usually referred to when land is required within highways boundaries. The boundaries between private land and highways property are assumed by using obvious demarcation such as fence lines/hedges etc. It should be noted that actual boundaries between highways and private land are not substantiated in this report and can only be authenticated by carrying out land searches.
- Police escorts and permits will be required for the movement of all of the components. Form 'BE16' permits will also be required to undertake the movement of the vehicle shown in the swept path analysis. These permits are at the discretion of the Highway Agency (HA). Therefore, approval of these 'permits for movements' by the HA are a major consideration before the physical capability to deliver these components are undertaken.
- In critical areas, where modifications are required, the road construction must be formed to the minimum specification contained in the Turbine Manufactures Transport Guidance Notes.
- The Turbine Manufactures Transport Guidance Notes will state the minimum road width required for the transport of components. Any roads below this stated width will require widening to reflect this regardless of any swept path analysis not indicating modifications.
- The information is privileged and confidential and is for the exclusive use of the nominated client.
- All dimensions in metres.
- © Crown copyright and database rights 2014. Ordnance Survey 0100031673 (EMAP)

UK Grid Reference: NT 75081 73052

- Area within red outline will be swept by tractor and trailer axles
- ▨ Hatched area within red outline to be levelled and prepared to accept axle loadings
- Area within magenta outline will be oversailed by load and projections
- Area within green outline will be oversailed by trailer body



COLLETT & SONS LIMITED
Victoria Terminal TEL: +44(0)8456 255288
Albert Road FAX: +44(0)8456 255244
Halifax, HX2 0DF WEB: www.collett.co.uk

DRAWN	RJW	TITLE	RIGHT BEND ON TRACK nr LAWFIELD COTTAGE	
DATE	10/11/2022	MAPPING	ORDNANCE SURVEY NOT ADJUSTED	CUSTOMER
SCALE	1:500	SIZE	A3	PINCH POINT IDENTIFIED BY
			COLLETT	SITE BRANXTON ENERGY STORAGE
				DWG. NO. 380548-340A0.1
				EASTCOASTGRIDSERVICESLtd

Swept Path indicates trailer utilising AUTOMATIC steering

Example Transformer on 8 Axle Modular Trailer
Ballast Tractor w/drawbar
Transformer Dims for Indicative Purposes only

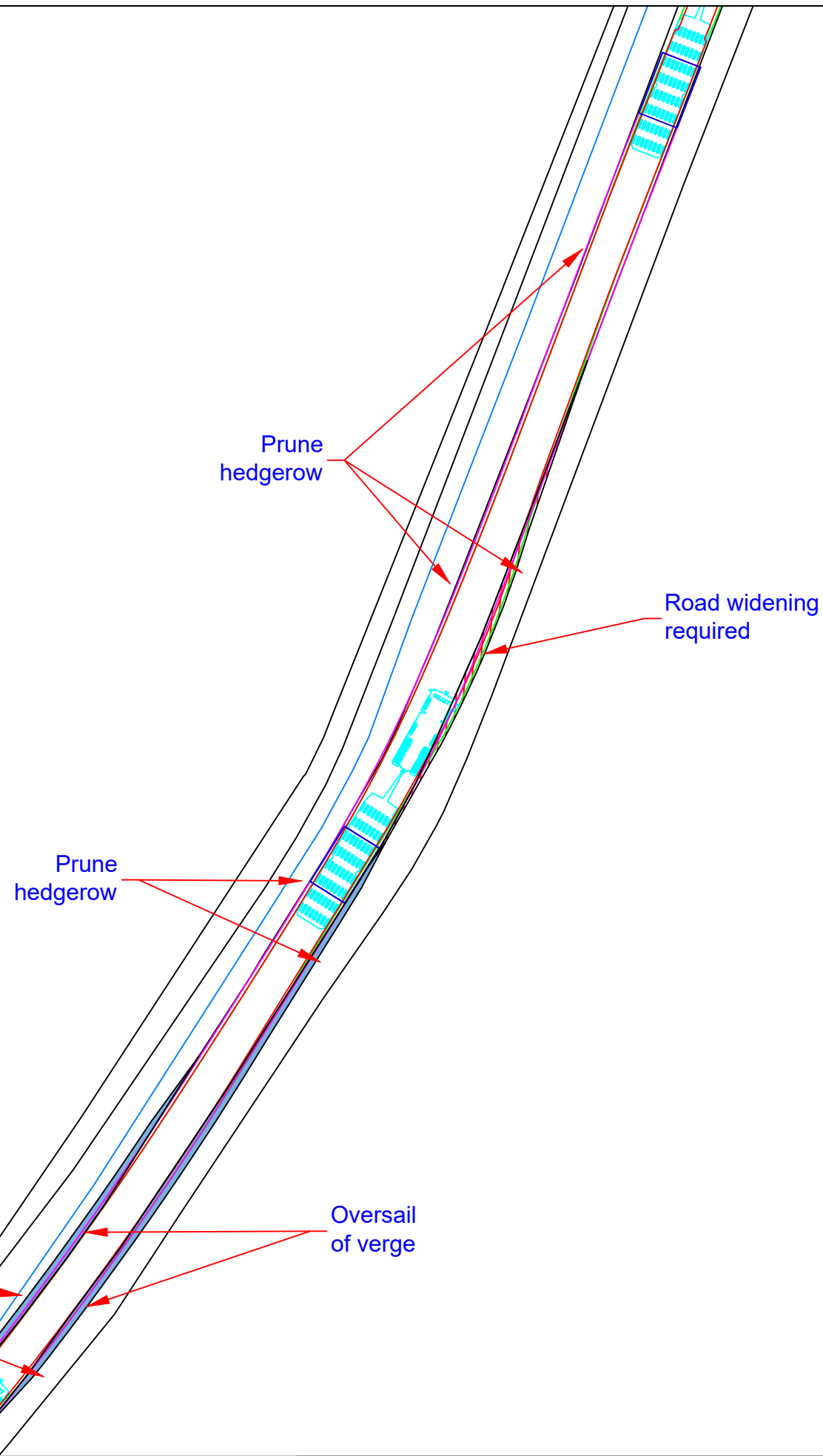
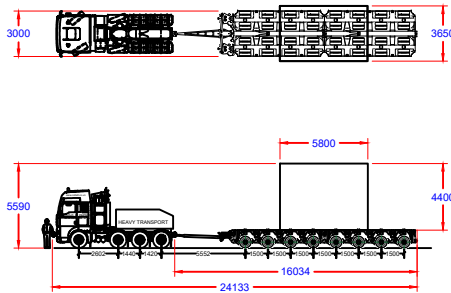

Continue along road.

****Caution****

- Road widening is required on the offside in the red hatched area.
- Oversail occurs on both sides of the road demarked in solid blue.
- Hedgerows/ vegetation are to be pruned on both sides where indicated.
- Road to be upgraded to meet manufacturer's specification where necessary.
- The centre of gravity is assumed to be centre of the load, as agreed by client.

- The swept path analysis provided is produced from a purely transport orientated view, and does not consider any political issues in terms of land ownership, or any other precincts raised, that may otherwise be restrictive.
- The drawing has been produced from Ordnance Survey Data and adjusted where necessary to reflect measurements taken on site with a tape measure.
- All swept path diagrams and assessments are made and calculated for the road movement of loaded trailer equipment carrying Turbine components. These dimensions are based on the turning circles and specification of Collett & Sons Ltd trailer equipment.
- This SPA is a means of providing evidence of minimum requirements of any one vehicle as a footprint and there is no safety factor or margin included.
- Turbine delivery vehicles can be both left and right hand drive vehicles, therefore due to drivers perception it must be assumed that every vehicle will not follow the exact same line and so a margin of additional space should be allowed for.
- Land take is usually referred to when land is required from Private Land Owners; road widening is usually referred to when land is required within highways boundaries. The boundaries between private land and highways property are assumed by using obvious demarcation such as fence lines/hedges etc. It should be noted that actual boundaries between highways and private land are not substantiated in this report and can only be authenticated by carrying out land searches.
- Police escorts and permits will be required for the movement of all of the components. Form 'BE16' permits will also be required to undertake the movement of the vehicle shown in the swept path analysis. These permits are at the discretion of the Highway Agency (HA). Therefore, approval of these 'permits for movements' by the HA are a major consideration before the physical capability to deliver these components are undertaken.
- In critical areas, where modifications are required, the road construction must be formed to the minimum specification contained in the Turbine Manufactures Transport Guidance Notes.
- The Turbine Manufactures Transport Guidance Notes will state the minimum road width required for the transport of components. Any roads below this stated width will require widening to reflect this regardless of any swept path analysis not indicating modifications.
- The information is privileged and confidential and is for the exclusive use of the nominated client.
- All dimensions in metres.
- © Crown copyright and database rights 2014. Ordnance Survey 0100031673 (EMAP)

UK Grid Reference: NT 75159 73140

- Area within red outline will be swept by tractor and trailer axles
- ▨ Hatched area within red outline to be levelled and prepared to accept axle loadings
- Area within magenta outline will be oversailed by load and projections
- Area within green outline will be oversailed by trailer body



COLLETT & SONS LIMITED
Victoria Terminal TEL: +44(0)8456 255288
Albert Road FAX: +44(0)8456 255244
Halifax, HX2 0DF WEB: www.collett.co.uk

DRAWN RJW
DATE 10/11/2022
SCALE 1:500 SIZE A3

TITLE
MAPPING ORDNANCE SURVEY NOT ADJUSTED
PINCH POINT IDENTIFIED BY COLLETT

LEFT BEND ON TRACK
CUSTOMER EASTCOASTGRIDSERVICESLtd
SITE BRANXTON ENERGY STORAGE DWG. NO. 380548-350A0.1

Swept Path indicates trailer utilising MANUAL steering

Example Transformer on 8 Axle Modular Trailer
Ballast Tractor w/drawbar
Transformer Dims for Indicative Purposes only

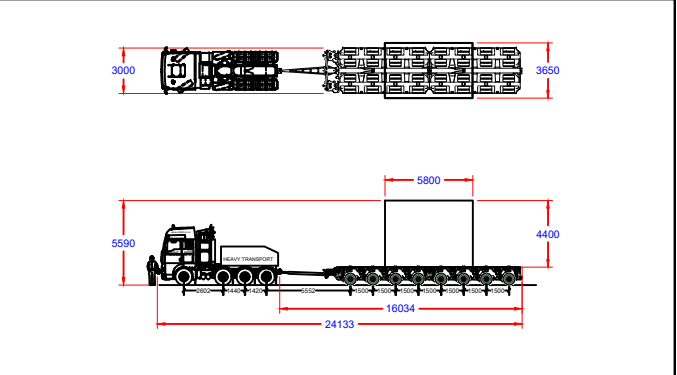

Continue along road.

- **Caution****
- Road widening is required on the nearside in the red hatched area.
 - Oversail will occur on the offside in the solid blue area.
 - The embankment on the offside will require to be cut back.
 - Drainage channel on the nearside is to be culverted where necessary.
 - Trees/ Hedgerows are to be pruned where indicated.
 - Road to be upgraded to meet manufacturer's specification where necessary.
 - The centre of gravity is assumed to be centre of the load, as agreed by client.

- The swept path analysis provided is produced from a purely transport orientated view, and does not consider any political issues in terms of land ownership, or any other precincts raised, that may otherwise be restrictive.
- The drawing has been produced from Ordnance Survey Data and adjusted where necessary to reflect measurements taken on site with a tape measure.
- All swept path diagrams and assessments are made and calculated for the road movement of loaded trailer equipment carrying Turbine components. These dimensions are based on the turning circles and specification of Collett & Sons Ltd trailer equipment.
- This SPA is a means of providing evidence of minimum requirements of any one vehicle as a footprint and there is no safety factor or margin included.
- Turbine delivery vehicles can be both left and right hand drive vehicles, therefore due to drivers perception it must be assumed that every vehicle will not follow the exact same line and so a margin of additional space should be allowed for.
- Land take is usually referred to when land is required from Private Land Owners; road widening is usually referred to when land is required within highways boundaries. The boundaries between private land and highways property are assumed by using obvious demarcation such as fence lines/hedges etc. It should be noted that actual boundaries between highways and private land are not substantiated in this report and can only be authenticated by carrying out land searches.
- Police escorts and permits will be required for the movement of all of the components. Form 'BE16' permits will also be required to undertake the movement of the vehicle shown in the swept path analysis. These permits are at the discretion of the Highway Agency (HA). Therefore, approval of these 'permits for movements' by the HA are a major consideration before the physical capability to deliver these components are undertaken.
- In critical areas, where modifications are required, the road construction must be formed to the minimum specification contained in the Turbine Manufactures Transport Guidance Notes.
- The Turbine Manufactures Transport Guidance Notes will state the minimum road width required for the transport of components. Any roads below this stated width will require widening to reflect this regardless of any swept path analysis not indicating modifications.
- The information is privileged and confidential and is for the exclusive use of the nominated client.
- All dimensions in metres.
- © Crown copyright and database rights 2014. Ordnance Survey 0100031673 (EMAP)

UK Grid Reference: NT 75284 73414

- Area within red outline will be swept by tractor and trailer axles
- ▨ Hatched area within red outline to be levelled and prepared to accept axle loadings
- Area within magenta outline will be oversailed by load and projections
- Area within green outline will be oversailed by trailer body

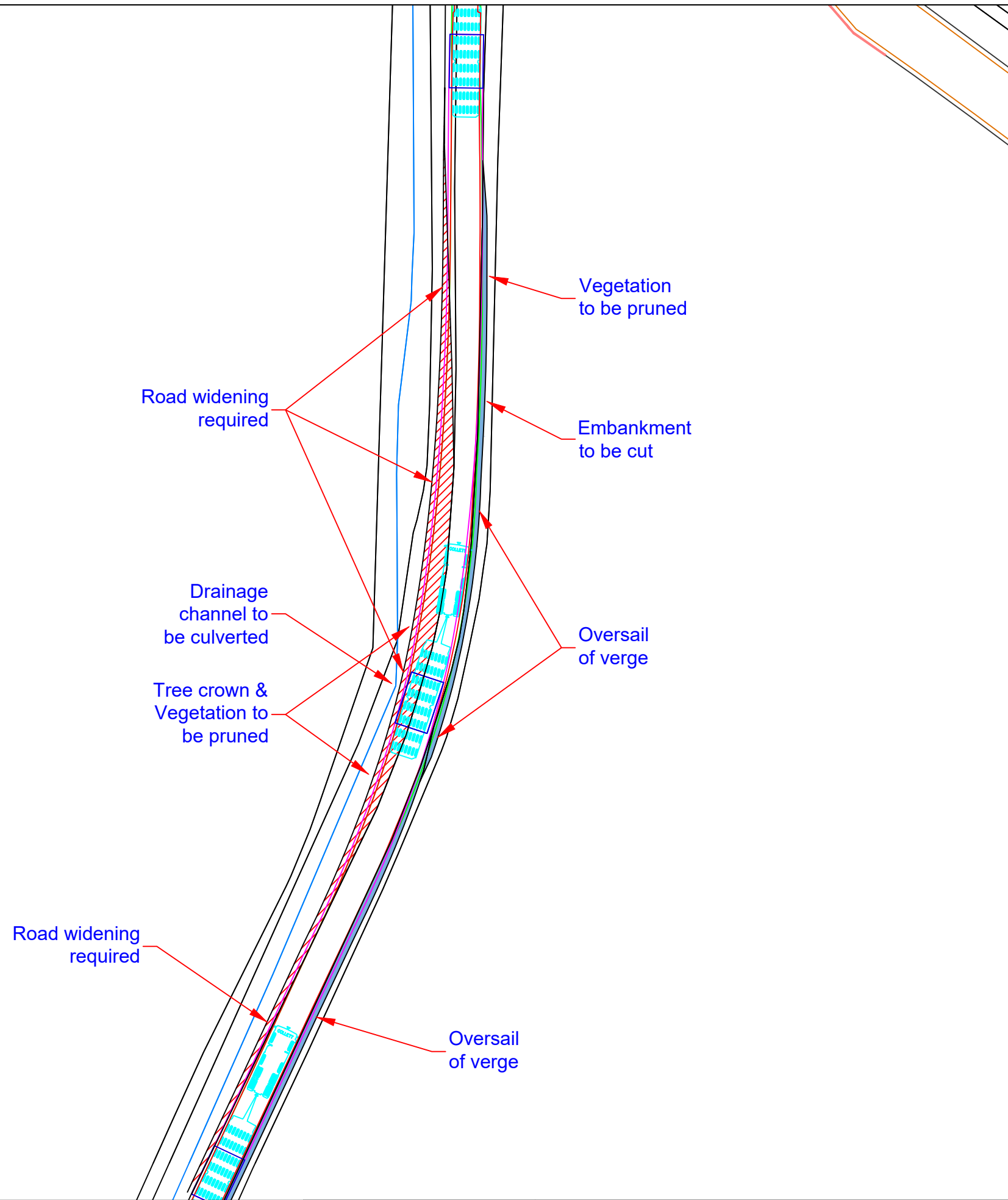

COLLETT & SONS LIMITED
Victoria Terminal TEL: +44(0)8456 255288
Albert Road FAX: +44(0)8456 255244
Halifax, HX2 0DF WEB: www.collett.co.uk

DRAWN	RJW	TITLE	LEFT BEND ON TRACK	
DATE	10/11/2022	MAPPING	ORDNANCE SURVEY NOT ADJUSTED	CUSTOMER
SCALE	1:500	SIZE	A3	PINCH POINT IDENTIFIED BY
		COLLETT		SITE
		BRANXTON ENERGY STORAGE		DWG. NO.
		380548-360A1.1		

Swept Path indicates trailer utilising MANUAL steering

Example Transformer on 8 Axle Modular Trailer
Ballast Tractor w/drawbar
Transformer Dims for Indicative Purposes only

Continue on unnamed road, turn left onto site prior to the railway bridge.

- **Caution****
- Road widening is required on the nearside in the red hatched area.
 - The drainage channel on the nearside will require culverting.
 - Street furniture is to be removed where indicated.
 - Trees/ Vegetation are to be removed/ pruned where indicated.
 - Manual steering & utilisation of the full extents of the road are required at this location.
 - The centre of gravity is assumed to be centre of the load, as agreed by client.

- The swept path analysis provided is produced from a purely transport orientated view, and does not consider any political issues in terms of land ownership, or any other precincts raised, that may otherwise be restrictive.
- The drawing has been produced from Ordnance Survey Data and adjusted where necessary to reflect measurements taken on site with a tape measure.
- All swept path diagrams and assessments are made and calculated for the road movement of loaded trailer equipment carrying Turbine components. These dimensions are based on the turning circles and specification of Collett & Sons Ltd trailer equipment.
- This SPA is a means of providing evidence of minimum requirements of any one vehicle as a footprint and there is no safety factor or margin included.
- Turbine delivery vehicles can be both left and right hand drive vehicles, therefore due to drivers perception it must be assumed that every vehicle will not follow the exact same line and so a margin of additional space should be allowed for.
- Land take is usually referred to when land is required from Private Land Owners; road widening is usually referred to when land is required within highways boundaries. The boundaries between private land and highways property are assumed by using obvious demarcation such as fence lines/hedges etc. It should be noted that actual boundaries between highways and private land are not substantiated in this report and can only be authenticated by carrying out land searches.
- Police escorts and permits will be required for the movement of all of the components. Form 'BE16' permits will also be required to undertake the movement of the vehicle shown in the swept path analysis. These permits are at the discretion of the Highway Agency (HA). Therefore, approval of these 'permits for movements' by the HA are a major consideration before the physical capability to deliver these components are undertaken.
- In critical areas, where modifications are required, the road construction must be formed to the minimum specification contained in the Turbine Manufactures Transport Guidance Notes.
- The Turbine Manufactures Transport Guidance Notes will state the minimum road width required for the transport of components. Any roads below this stated width will require widening to reflect this regardless of any swept path analysis not indicating modifications.
- The information is privileged and confidential and is for the exclusive use of the nominated client.
- All dimensions in metres.
- © Crown copyright and database rights 2014. Ordnance Survey 0100031673 (EMAP)

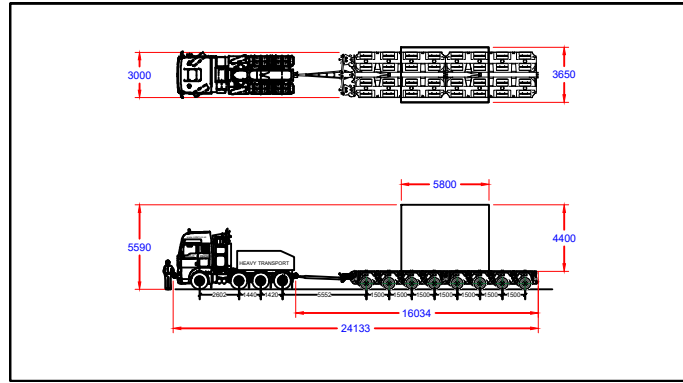
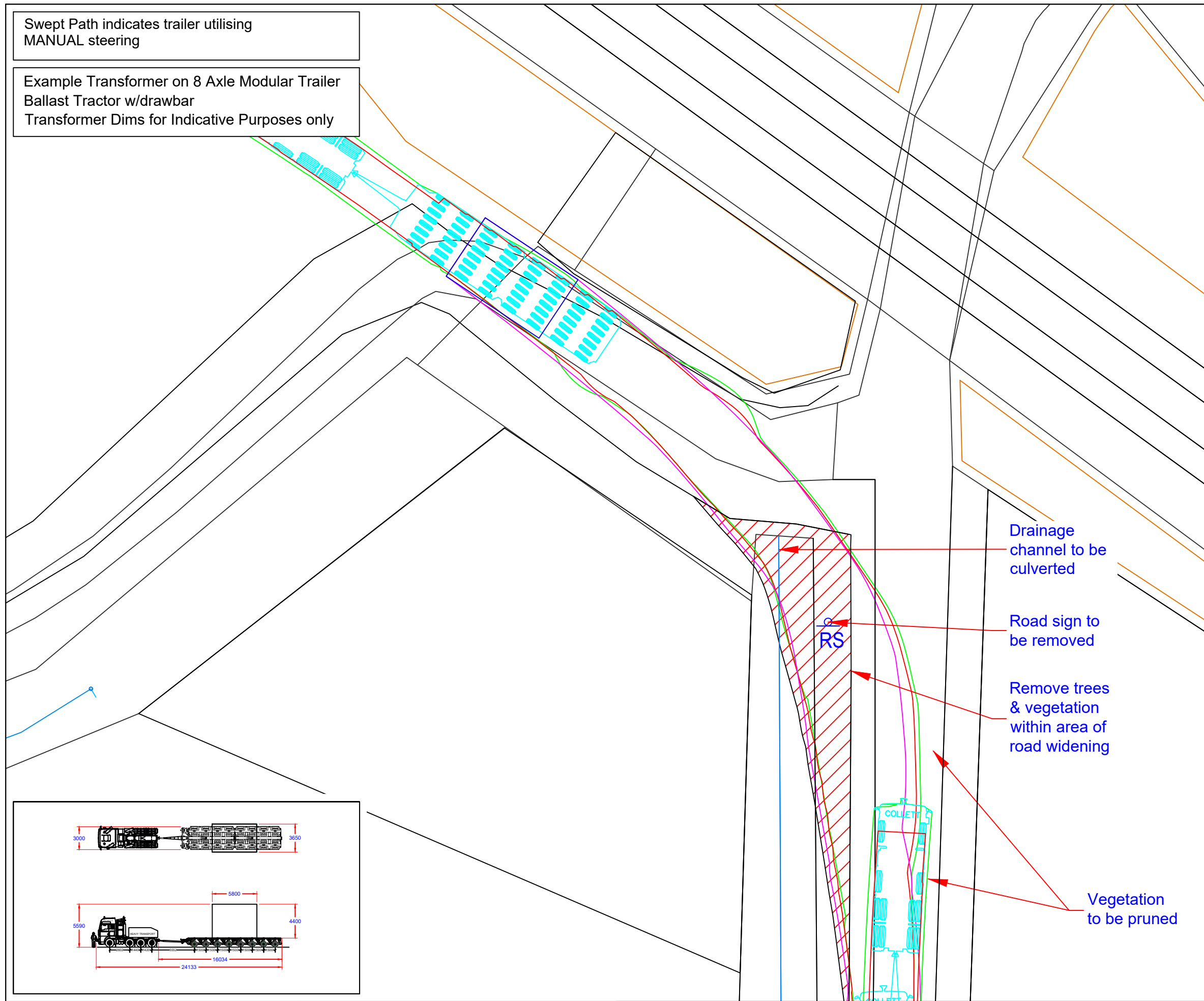

UK Grid Reference: NT 75285 73509

- Area within red outline will be swept by tractor and trailer axles
- ▨ Hatched area within red outline to be levelled and prepared to accept axle loadings
- Area within magenta outline will be oversailed by load and projections
- Area within green outline will be oversailed by trailer body

	COLLETT & SONS LIMITED Victoria Terminal TEL: +44(0)8456 255288 Albert Road FAX: +44(0)8456 255244 Halifax, HX2 0DF WEB: www.collett.co.uk	DRAWN RJW DATE 08/11/2022 SCALE 1:200 SIZE A3	TITLE LEFT TURN INTO SITE MAPPING ORDNANCE SURVEY NOT ADJUSTED PINCH POINT IDENTIFIED BY COLLETT	CUSTOMER EASTCOASTGRIDSERVICESLtd SITE BRANXTON ENERGY STORAGE DWG. NO. 380548-370A1.1

Swept Path indicates trailer utilising MANUAL steering

Example Transformer on 8 Axle Modular Trailer
Ballast Tractor w/drawbar
Transformer Dims for Indicative Purposes only

Continue on A1. Turn right onto small rest area prior to the bridge crossing Dunglass Burn.

****Caution****

- Road widening is required in the red hatched area.
- Fence restricting access to road under the viaduct is to be removed.
- Trees/ Vegetation are to be pruned where indicated.
- Parking restrictions should be implemented to avoid hindering the exit from the A1.
- The centre of gravity is assumed to be centre of the load, as agreed by client.

- The swept path analysis provided is produced from a purely transport orientated view, and does not consider any political issues in terms of land ownership, or any other precincts raised, that may otherwise be restrictive.
- The drawing has been produced from Ordnance Survey Data and adjusted where necessary to reflect measurements taken on site with a tape measure.
- All swept path diagrams and assessments are made and calculated for the road movement of loaded trailer equipment carrying Turbine components. These dimensions are based on the turning circles and specification of Collett & Sons Ltd trailer equipment.
- This SPA is a means of providing evidence of minimum requirements of any one vehicle as a footprint and there is no safety factor or margin included.
- Turbine delivery vehicles can be both left and right hand drive vehicles, therefore due to drivers perception it must be assumed that every vehicle will not follow the exact same line and so a margin of additional space should be allowed for.
- Land take is usually referred to when land is required from Private Land Owners; road widening is usually referred to when land is required within highways boundaries. The boundaries between private land and highways property are assumed by using obvious demarcation such as fence lines/hedges etc. It should be noted that actual boundaries between highways and private land are not substantiated in this report and can only be authenticated by carrying out land searches.
- Police escorts and permits will be required for the movement of all of the components. Form 'BE16' permits will also be required to undertake the movement of the vehicle shown in the swept path analysis. These permits are at the discretion of the Highway Agency (HA). Therefore, approval of these 'permits for movements' by the HA are a major consideration before the physical capability to deliver these components are undertaken.
- In critical areas, where modifications are required, the road construction must be formed to the minimum specification contained in the Turbine Manufactures Transport Guidance Notes.
- The Turbine Manufactures Transport Guidance Notes will state the minimum road width required for the transport of components. Any roads below this stated width will require widening to reflect this regardless of any swept path analysis not indicating modifications.
- The information is privileged and confidential and is for the exclusive use of the nominated client.
- All dimensions in metres.
- © Crown copyright and database rights 2014. Ordnance Survey 0100031673 (EMAP)

Road widening required

Remove fence

Prune trees/vegetation

Parking restrictions required

UK Grid Reference: NT 77050 72223

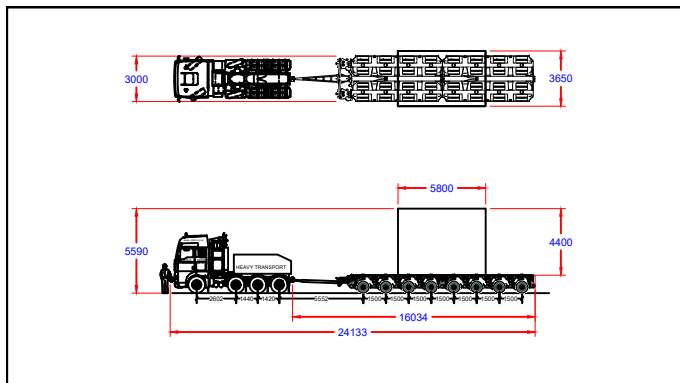

- Area within red outline will be swept by tractor and trailer axles
- ▨ Hatched area within red outline to be levelled and prepared to accept axle loadings
- Area within magenta outline will be oversailed by load and projections
- Area within green outline will be oversailed by trailer body

COLLETT
EXPERTS IN MOTION

COLLETT & SONS LIMITED
Victoria Terminal TEL: +44(0)8456 255288
Albert Road FAX: +44(0)8456 255244
Halifax, HX2 0DF WEB: www.collett.co.uk

DRAWN	RJW	TITLE	RIGHT TURN OFF A1 ONTO CLOSED ROAD, DUNGLASS	
DATE	08/11/2022	MAPPING	ORDNANCE SURVEY NOT ADJUSTED	CUSTOMER
SCALE	1:250	SIZE	A3	PINCH POINT IDENTIFIED BY
			COLLETT	SITE BRANXTON ENERGY STORAGE
				DWG. NO. 380548-400A0.1

Swept Path indicates trailer utilising MANUAL steering

Example Transformer on 8 Axle Modular Trailer
Ballast Tractor w/drawbar
Transformer Dims for Indicative Purposes only

Continue along road.

****Caution****

- Vegetation is to be pruned where indicated.
- Manual steering & utilisation of the full extents of the road are required at this location.
- The centre of gravity is assumed to be centre of the load, as agreed by client.

Prune trees

- The swept path analysis provided is produced from a purely transport orientated view, and does not consider any political issues in terms of land ownership, or any other precincts raised, that may otherwise be restrictive.
- The drawing has been produced from Ordnance Survey Data and adjusted where necessary to reflect measurements taken on site with a tape measure.
- All swept path diagrams and assessments are made and calculated for the road movement of loaded trailer equipment carrying Turbine components. These dimensions are based on the turning circles and specification of Collett & Sons Ltd trailer equipment.
- This SPA is a means of providing evidence of minimum requirements of any one vehicle as a footprint and there is no safety factor or margin included.
- Turbine delivery vehicles can be both left and right hand drive vehicles, therefore due to drivers perception it must be assumed that every vehicle will not follow the exact same line and so a margin of additional space should be allowed for.
- Land take is usually referred to when land is required from Private Land Owners; road widening is usually referred to when land is required within highways boundaries. The boundaries between private land and highways property are assumed by using obvious demarcation such as fence lines/hedges etc. It should be noted that actual boundaries between highways and private land are not substantiated in this report and can only be authenticated by carrying out land searches.
- Police escorts and permits will be required for the movement of all of the components. Form 'BE16' permits will also be required to undertake the movement of the vehicle shown in the swept path analysis. These permits are at the discretion of the Highway Agency (HA). Therefore, approval of these 'permits for movements' by the HA are a major consideration before the physical capability to deliver these components are undertaken.
- In critical areas, where modifications are required, the road construction must be formed to the minimum specification contained in the Turbine Manufactures Transport Guidance Notes.
- The Turbine Manufactures Transport Guidance Notes will state the minimum road width required for the transport of components. Any roads below this stated width will require widening to reflect this regardless of any swept path analysis not indicating modifications.
- The information is privileged and confidential and is for the exclusive use of the nominated client.
- All dimensions in metres.
- © Crown copyright and database rights 2014. Ordnance Survey 0100031673 (EMAP)

UK Grid Reference: NT 76950 72197

- Area within red outline will be swept by tractor and trailer axles
- ▨ Hatched area within red outline to be levelled and prepared to accept axle loadings
- Area within magenta outline will be oversailed by load and projections
- Area within green outline will be oversailed by trailer body

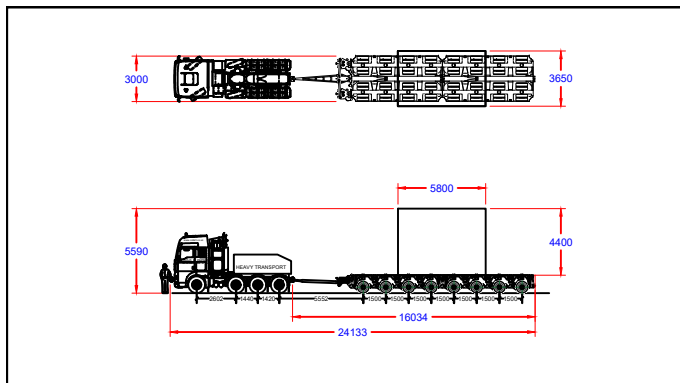

COLLETT
EXPERTS IN MOTION

COLLETT & SONS LIMITED
Victoria Terminal TEL: +44(0)8456 255288
Albert Road FAX: +44(0)8456 255244
Halifax, HX2 0DF WEB: www.collett.co.uk

DRAWN	RJW	TITLE	LEFT BEND, DUNGLASS	
DATE	10/11/2022	MAPPING	ORDNANCE SURVEY NOT ADJUSTED	CUSTOMER
SCALE	1:250	SIZE	A3	PINCH POINT IDENTIFIED BY
			COLLETT	SITE BRANXTON ENERGY STORAGE
				DWG. NO. 380548-420A1.1
				EASTCOASTGRIDSERVICESLtd

Swept Path indicates trailer utilising MANUAL steering

Example Transformer on 8 Axle Modular Trailer
Ballast Tractor w/drawbar
Transformer Dims for Indicative Purposes only

Continue along road.

****Caution****

- Trees including crowns are to be pruned where indicated.
- Manual steering & utilisation of the full extents of the road are required at this location.
- The centre of gravity is assumed to be centre of the load, as agreed by client.

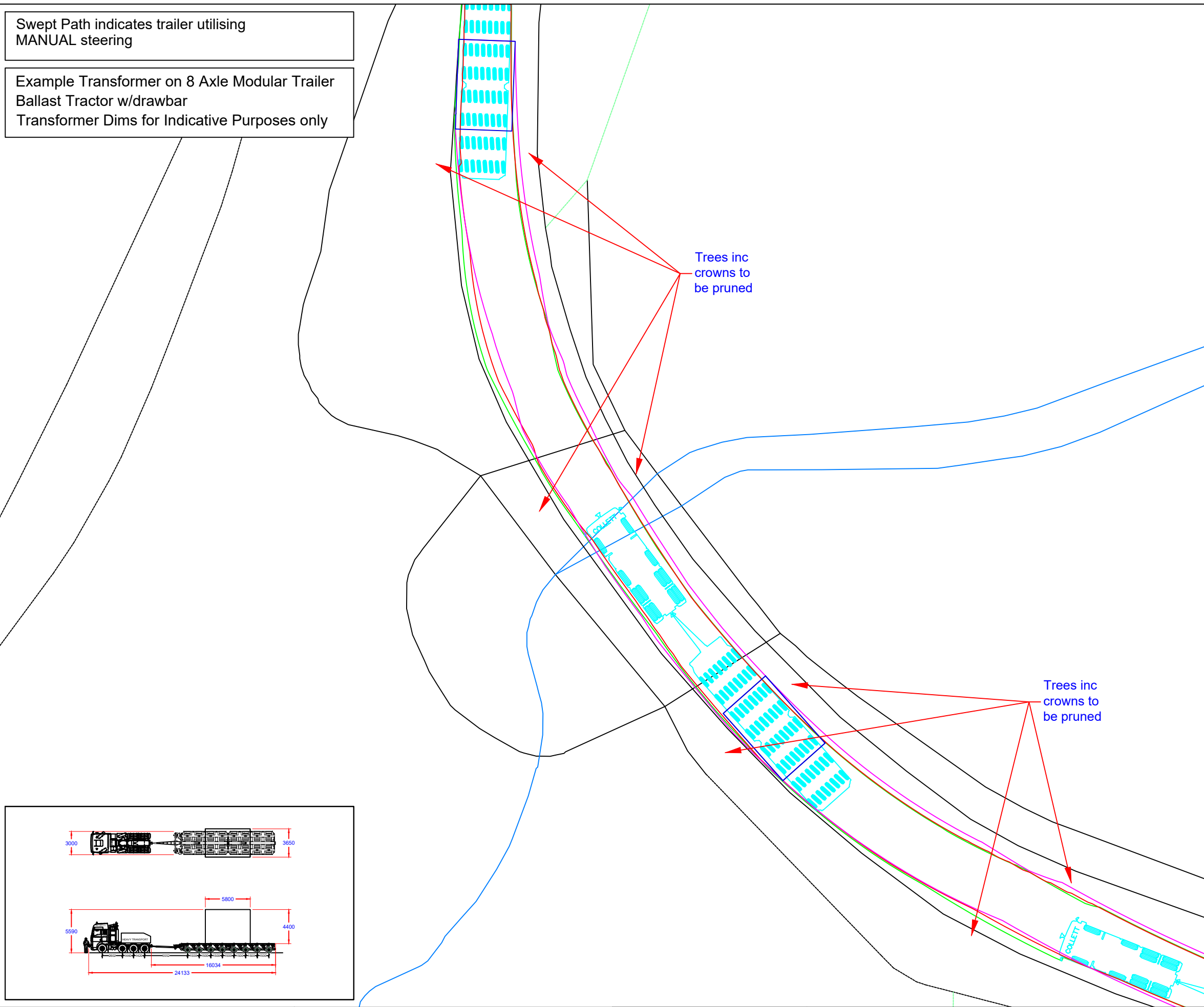

- The swept path analysis provided is produced from a purely transport orientated view, and does not consider any political issues in terms of land ownership, or any other precincts raised, that may otherwise be restrictive.
- The drawing has been produced from Ordnance Survey Data and adjusted where necessary to reflect measurements taken on site with a tape measure.
- All swept path diagrams and assessments are made and calculated for the road movement of loaded trailer equipment carrying Turbine components. These dimensions are based on the turning circles and specification of Collett & Sons Ltd trailer equipment.
- This SPA is a means of providing evidence of minimum requirements of any one vehicle as a footprint and there is no safety factor or margin included.
- Turbine delivery vehicles can be both left and right hand drive vehicles, therefore due to drivers perception it must be assumed that every vehicle will not follow the exact same line and so a margin of additional space should be allowed for.
- Land take is usually referred to when land is required from Private Land Owners; road widening is usually referred to when land is required within highways boundaries. The boundaries between private land and highways property are assumed by using obvious demarcation such as fence lines/hedges etc. It should be noted that actual boundaries between highways and private land are not substantiated in this report and can only be authenticated by carrying out land searches.
- Police escorts and permits will be required for the movement of all of the components. Form 'BE16' permits will also be required to undertake the movement of the vehicle shown in the swept path analysis. These permits are at the discretion of the Highway Agency (HA). Therefore, approval of these 'permits for movements' by the HA are a major consideration before the physical capability to deliver these components are undertaken.
- In critical areas, where modifications are required, the road construction must be formed to the minimum specification contained in the Turbine Manufactures Transport Guidance Notes.
- The Turbine Manufactures Transport Guidance Notes will state the minimum road width required for the transport of components. Any roads below this stated width will require widening to reflect this regardless of any swept path analysis not indicating modifications.
- The information is privileged and confidential and is for the exclusive use of the nominated client.
- All dimensions in metres.
- © Crown copyright and database rights 2014. Ordnance Survey 0100031673 (EMAP)

UK Grid Reference: NT 76296 72515

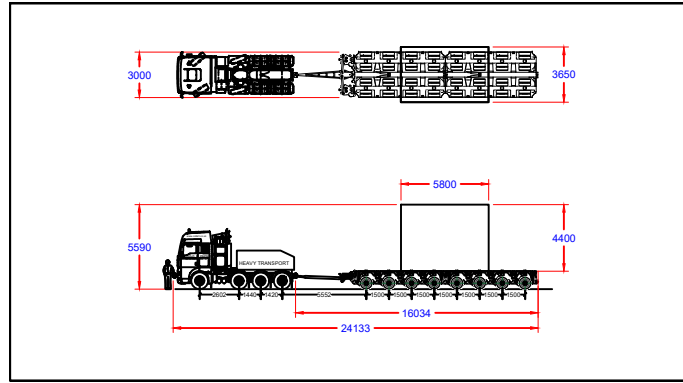

- Area within red outline will be swept by tractor and trailer axles
- ▨ Hatched area within red outline to be levelled and prepared to accept axle loadings
- Area within magenta outline will be oversailed by load and projections
- Area within green outline will be oversailed by trailer body

	COLLETT & SONS LIMITED Victoria Terminal TEL: +44(0)8456 255288 Albert Road FAX: +44(0)8456 255244 Halifax, HX2 0DF WEB: www.collett.co.uk	DRAWN RJW DATE 10/11/2022 SCALE 1:250 SIZE A3	TITLE MAPPING ORDNANCE SURVEY NOT ADJUSTED PINCH POINT IDENTIFIED BY COLLETT	RIGHT BEND, BILSDEAN CUSTOMER EASTCOASTGRIDSERVICESLtd SITE BRANXTON ENERGY STORAGE DWG. NO. 380548-430A1.1
--	--	---	--	---

Swept Path indicates trailer utilising MANUAL steering

Example Transformer on 8 Axle Modular Trailer
Ballast Tractor w/drawbar
Transformer Dims for Indicative Purposes only

Continue to junction. Turn right at the junction.

****Caution****

- Oversail will occur on the nearside of the road after the turn.
- Vegetation is to be pruned where indicated.
- Manual steering & utilisation of the full extents of the road are required at this location.

- The centre of gravity is assumed to be centre of the load, as agreed by client.

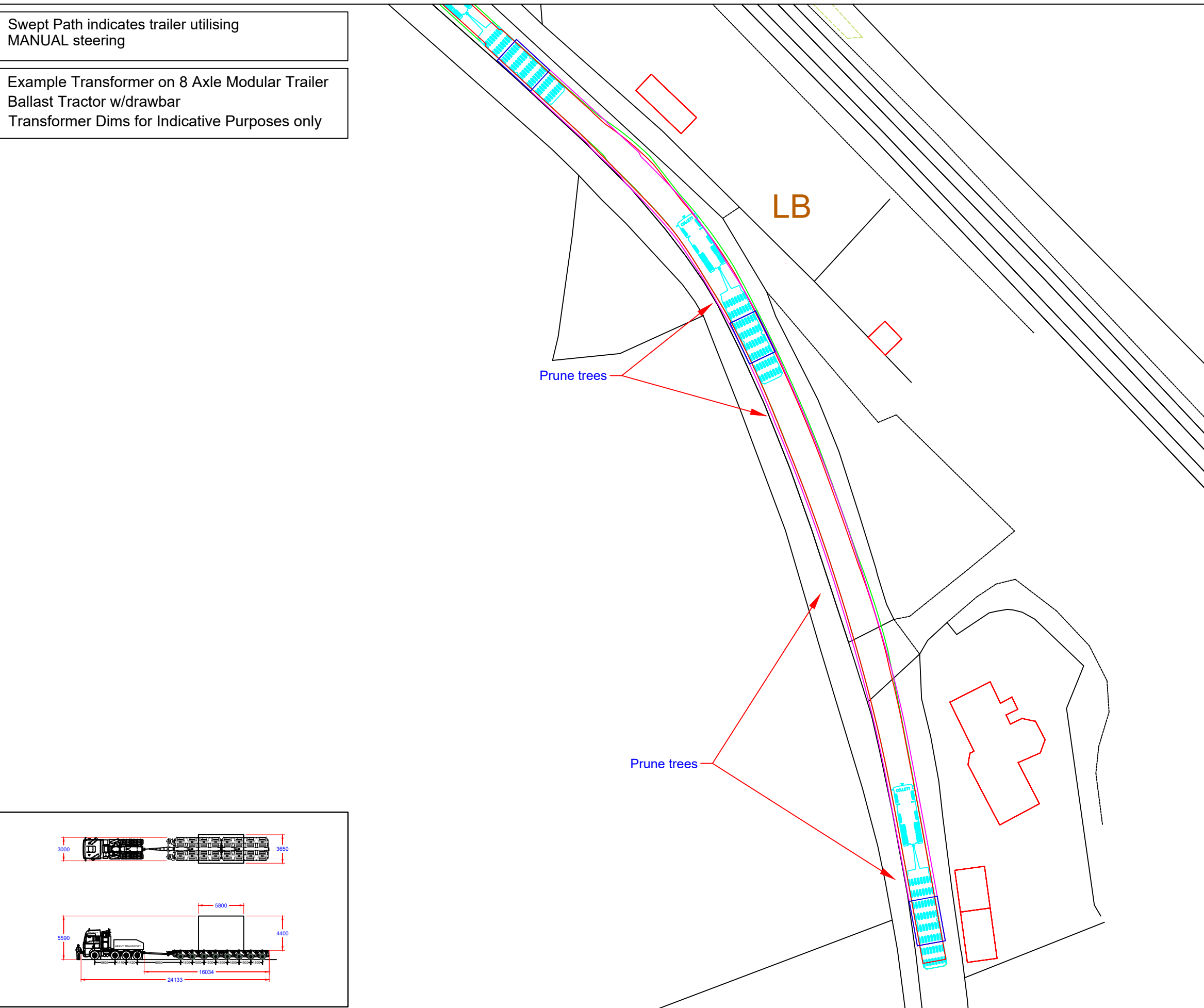

- The swept path analysis provided is produced from a purely transport orientated view, and does not consider any political issues in terms of land ownership, or any other precincts raised, that may otherwise be restrictive.
- The drawing has been produced from Ordnance Survey Data and adjusted where necessary to reflect measurements taken on site with a tape measure.
- All swept path diagrams and assessments are made and calculated for the road movement of loaded trailer equipment carrying Turbine components. These dimensions are based on the turning circles and specification of Collett & Sons Ltd trailer equipment.
- This SPA is a means of providing evidence of minimum requirements of any one vehicle as a footprint and there is no safety factor or margin included.
- Turbine delivery vehicles can be both left and right hand drive vehicles, therefore due to drivers perception it must be assumed that every vehicle will not follow the exact same line and so a margin of additional space should be allowed for.
- Land take is usually referred to when land is required from Private Land Owners; road widening is usually referred to when land is required within highways boundaries. The boundaries between private land and highways property are assumed by using obvious demarcation such as fence lines/hedges etc. It should be noted that actual boundaries between highways and private land are not substantiated in this report and can only be authenticated by carrying out land searches.
- Police escorts and permits will be required for the movement of all of the components. Form 'BE16' permits will also be required to undertake the movement of the vehicle shown in the swept path analysis. These permits are at the discretion of the Highway Agency (HA). Therefore, approval of these 'permits for movements' by the HA are a major consideration before the physical capability to deliver these components are undertaken.
- In critical areas, where modifications are required, the road construction must be formed to the minimum specification contained in the Turbine Manufactures Transport Guidance Notes.
- The Turbine Manufactures Transport Guidance Notes will state the minimum road width required for the transport of components. Any roads below this stated width will require widening to reflect this regardless of any swept path analysis not indicating modifications.
- The information is privileged and confidential and is for the exclusive use of the nominated client.
- All dimensions in metres.
- © Crown copyright and database rights 2014. Ordnance Survey 0100031673 (EMAP)

UK Grid Reference: NT 76253 72698

- Area within red outline will be swept by tractor and trailer axles
- ▨ Hatched area within red outline to be levelled and prepared to accept axle loadings
- Area within magenta outline will be oversailed by load and projections
- Area within green outline will be oversailed by trailer body

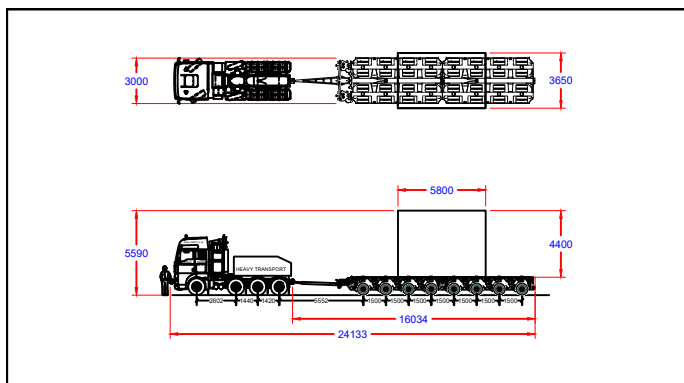

COLLETT & SONS LIMITED
Victoria Terminal TEL: +44(0)8456 255288
Albert Road FAX: +44(0)8456 255244
Halifax, HX2 0DF WEB: www.collett.co.uk

DRAWN	RJW	TITLE	LEFT BEND, BILSDEAN	
DATE	10/11/2022	MAPPING ORDNANCE SURVEY NOT ADJUSTED	CUSTOMER	EASTCOASTGRIDSERVICESLtd
SCALE	1:500	SIZE	A3	PINCH POINT IDENTIFIED BY COLLETT
SITE			BRANXTON ENERGY STORAGE	DWG. NO. 380548-440A1.1

Swept Path indicates trailer utilising MANUAL steering

Example Transformer on 8 Axle Modular Trailer
Ballast Tractor w/drawbar
Transformer Dims for Indicative Purposes only

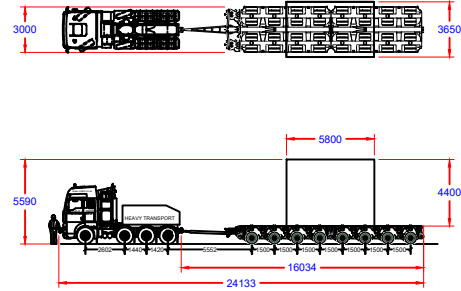

Continue on the road. Turn left towards Oldhamstocks before the bridge crossing the railway.
****Caution****

- Road widening is required in the red hatched areas.
- Oversail of the verge will occur on both sides of the second left bend.
- The hedgerow on the nearside of the second bend is to be pruned.
- Manual steering & utilisation of the full extents of the road are required at this location.
- The centre of gravity is assumed to be centre of the load, as agreed by client.

Road widening required

Area of Oversail

Prune hedgerow

GP

- The swept path analysis provided is produced from a purely transport orientated view, and does not consider any political issues in terms of land ownership, or any other precincts raised, that may otherwise be restrictive.
- The drawing has been produced from Ordnance Survey Data and adjusted where necessary to reflect measurements taken on site with a tape measure.
- All swept path diagrams and assessments are made and calculated for the road movement of loaded trailer equipment carrying Turbine components. These dimensions are based on the turning circles and specification of Collett & Sons Ltd trailer equipment.
- This SPA is a means of providing evidence of minimum requirements of any one vehicle as a footprint and there is no safety factor or margin included.
- Turbine delivery vehicles can be both left and right hand drive vehicles, therefore due to drivers perception it must be assumed that every vehicle will not follow the exact same line and so a margin of additional space should be allowed for.
- Land take is usually referred to when land is required from Private Land Owners; road widening is usually referred to when land is required within highways boundaries. The boundaries between private land and highways property are assumed by using obvious demarcation such as fence lines/hedges etc. It should be noted that actual boundaries between highways and private land are not substantiated in this report and can only be authenticated by carrying out land searches.
- Police escorts and permits will be required for the movement of all of the components. Form 'BE16' permits will also be required to undertake the movement of the vehicle shown in the swept path analysis. These permits are at the discretion of the Highway Agency (HA). Therefore, approval of these 'permits for movements' by the HA are a major consideration before the physical capability to deliver these components are undertaken.
- In critical areas, where modifications are required, the road construction must be formed to the minimum specification contained in the Turbine Manufactures Transport Guidance Notes.
- The Turbine Manufactures Transport Guidance Notes will state the minimum road width required for the transport of components. Any roads below this stated width will require widening to reflect this regardless of any swept path analysis not indicating modifications.
- The information is privileged and confidential and is for the exclusive use of the nominated client.
- All dimensions in metres.
- © Crown copyright and database rights 2014. Ordnance Survey 0100031673 (EMAP)

UK Grid Reference: NT 76083 72903

- Area within red outline will be swept by tractor and trailer axles
- ▨ Hatched area within red outline to be levelled and prepared to accept axle loadings
- Area within magenta outline will be oversailed by load and projections
- Area within green outline will be oversailed by trailer body



COLLETT & SONS LIMITED
Victoria Terminal TEL: +44(0)8456 255288
Albert Road FAX: +44(0)8456 255244
Halifax, HX2 0DF WEB: www.collett.co.uk

DRAWN	RJW	TITLE	LEFT TURN TOWARDS OLDHAMSTOCKS	
DATE	08/11/2022	MAPPING	ORDNANCE SURVEY NOT ADJUSTED	CUSTOMER
SCALE	1:500	SIZE	A3	PINCH POINT IDENTIFIED BY
		COLLETT		SITE
		BRANXTON ENERGY STORAGE		DWG. NO.
		380548-450A1.0		

Swept Path indicates trailer utilising MANUAL steering

Example Transformer on 8 Axle Modular Trailer
Ballast Tractor w/drawbar
Transformer Dims for Indicative Purposes only

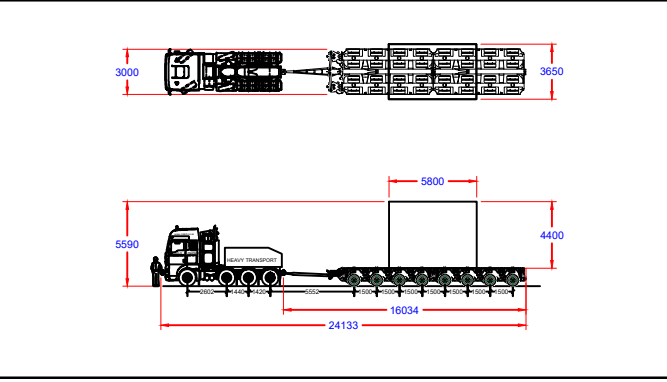

Continue to junction. Turn right at the junction.

****Caution****

- Road widening will be required on both sides of the road approaching the junction, as indicated by red hatching.
- Vegetation is to be pruned where indicated.
- Manual steering & utilisation of the full extents of the road are required at this location.
- The centre of gravity is assumed to be centre of the load, as agreed by client.

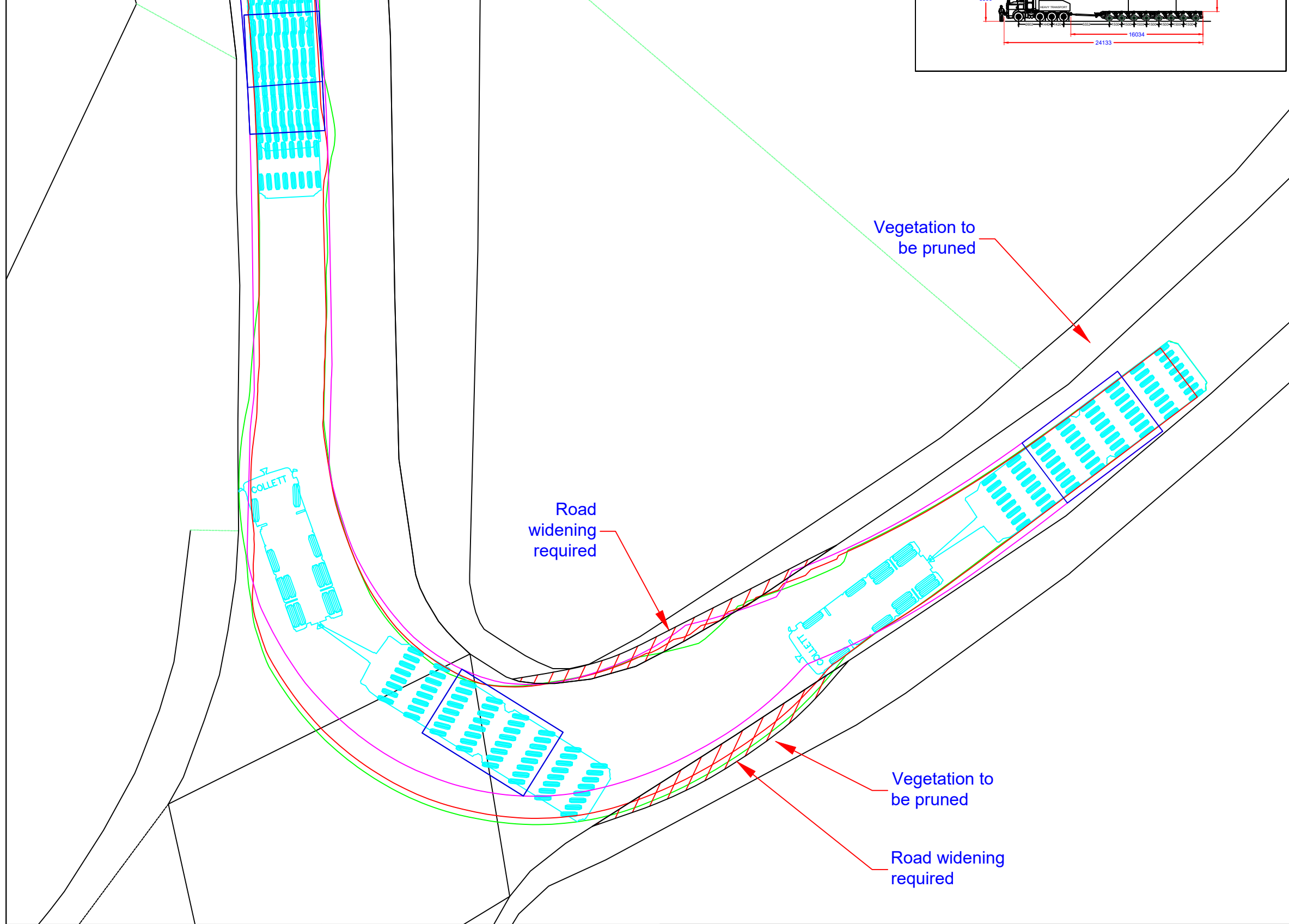

- The swept path analysis provided is produced from a purely transport orientated view, and does not consider any political issues in terms of land ownership, or any other precincts raised, that may otherwise be restrictive.
- The drawing has been produced from Ordnance Survey Data and adjusted where necessary to reflect measurements taken on site with a tape measure.
- All swept path diagrams and assessments are made and calculated for the road movement of loaded trailer equipment carrying Turbine components. These dimensions are based on the turning circles and specification of Collett & Sons Ltd trailer equipment.
- This SPA is a means of providing evidence of minimum requirements of any one vehicle as a footprint and there is no safety factor or margin included.
- Turbine delivery vehicles can be both left and right hand drive vehicles, therefore due to drivers perception it must be assumed that every vehicle will not follow the exact same line and so a margin of additional space should be allowed for.
- Land take is usually referred to when land is required from Private Land Owners; road widening is usually referred to when land is required within highways boundaries. The boundaries between private land and highways property are assumed by using obvious demarcation such as fence lines/hedges etc. It should be noted that actual boundaries between highways and private land are not substantiated in this report and can only be authenticated by carrying out land searches.
- Police escorts and permits will be required for the movement of all of the components. Form 'BE16' permits will also be required to undertake the movement of the vehicle shown in the swept path analysis. These permits are at the discretion of the Highway Agency (HA). Therefore, approval of these 'permits for movements' by the HA are a major consideration before the physical capability to deliver these components are undertaken.
- In critical areas, where modifications are required, the road construction must be formed to the minimum specification contained in the Turbine Manufactures Transport Guidance Notes.
- The Turbine Manufactures Transport Guidance Notes will state the minimum road width required for the transport of components. Any roads below this stated width will require widening to reflect this regardless of any swept path analysis not indicating modifications.
- The information is privileged and confidential and is for the exclusive use of the nominated client.
- All dimensions in metres.
- © Crown copyright and database rights 2014. Ordnance Survey 0100031673 (EMAP)

UK Grid Reference: NT 76963 72126

- Area within red outline will be swept by tractor and trailer axles
- ▨ Hatched area within red outline to be levelled and prepared to accept axle loadings
- Area within magenta outline will be oversailed by load and projections
- Area within green outline will be oversailed by trailer body



COLLETT & SONS LIMITED
Victoria Terminal TEL: +44(0)8456 255288
Albert Road FAX: +44(0)8456 255244
Halifax, HX2 0DF WEB: www.collett.co.uk

DRAWN	RJW	TITLE	RIGHT TURN OFF CLOSED ROAD, DUNGLASS	
DATE	08/11/2022	MAPPING	ORDNANCE SURVEY NOT ADJUSTED	CUSTOMER
SCALE	1:200	SIZE	A3	PINCH POINT IDENTIFIED BY
		COLLETT		SITE BRANXTON ENERGY STORAGE
				DWG. NO. 380548-410A1.1